

StarLine

E9 v2

Security-telematic system

User manual



Version 1.0.1

Content

Safety precautions	3
General description	7
Technical specification	9
Personal ID card	10
StarLine.online service and mobile app	11
Lights and sound indication	12
Control with wireless tag (transponder)	14
Control with 2-way remote key	16
Operation modes	32
Armed mode.....	32
Silent arming.....	33
Emergency arming	33
Disarmed mode	34
Automatic doors locking and unlocking on a trip.....	34
Trunk unlocking in armed mode	35
Blocking factory Keyless-Go system	35
Alarm mode.....	35
Panic mode.....	36
Anti-hijack mode.....	36
Slave mode.....	37
Hands free mode	38
Service (Valet) mode.....	39
Immobilizer mode.....	40
Remote engine start.....	41
Parking heater control.....	43
Intelligent turbotimer.....	44
Beach mode.....	45
Video recorder (dashcam) control.....	46
Risky parking	46
Accessories registration	47
Owner authorization code (Pin-to-Drive)	51
Emergency disarming	54
Optional accessories	57
Memo	60
Conformity statement	62
Warranty terms	63

Attention!

Read the manual prior to use security system and pay attention to the sections marked with . In order to check whether this security system is suitable for your car follow a vehicle instruction manual and manufacturer's requirements.

StarLine security system is a complicated technical appliance implying connection to vehicle wiring and equipment, including those related to engine operation.

It must be installed by qualified and trained auto electronics technicians only, passed necessary training and examined on safety rules observing.

The security system configured parameters shall not contradict a vehicle instruction manual requirements.

User bears a full responsibility on any damage incurred to people, animals and assets as a result of inappropriate use of security system and violation safety precautions specified in this manual.

Manufacturer shall not be responsible for any losses and injuries caused with breaching safety rules described herein.

If your security system has a remote key or a wireless tag (transponder) follow below recommendations:

- Do not carry remote key or tag on the same bundle with a car original keys
- Always switch over the system to service mode when handing a car over for maintenance or car wash. Do not give tags and remote keys to other persons in order to avoid unauthorized access to security functions
- Do not leave remote key or tags in children and animals reach
- Avoid any liquids ingress in remote key

- Replace battery in remote key once a battery drain warning icon appears on display
- Store a spare tag and/ or remote key battery in vehicle inside its factory packing

Mandatory safety precautions while use of remote engine start functionality

It should be borne in mind that a car is a source of extra hazard.

Driver can leave a vehicle only ensured that vehicle cannot move spontaneously or by unauthorized persons.

Study carefully the mandatory safety precautions for remote engine start option use:

1. Always park a vehicle at open and well ventilated area.
2. Always tighten a parking brake, which must be fully operable and insure of vehicle movement.
3. Make sure of leaving vehicle with automatic transmission shifted to parking position and manual transmission shifted to neutral.
4. On manual transmission version always execute “program neutral” procedure before leaving a vehicle to be able activate remote engine start then.
5. Never give the security system remote key, tag or mobile phone with StarLine app over children or other persons unless operation manual carefully studied.
6. Before remote engine start activation make sure of:
 - engine and entire vehicle are fully operable with no faults indicated on dashboard;

- sufficient level of fuel, oil, cooling and other technical fluids available;
- necessary parameters of climate control unit, heating and other accessories are preset;
- set fan regulator to an air circulation position for more effective cabin cooling or warming up.

Safety precautions while vehicle storage battery charging

Remember that any battery charging process implies supply of voltage exceeding the rated 12 V to the storage battery and accordingly to vehicle circuits, which may damage factory electronic and optional electronic equipment of vehicle.

Do not use charging and starting-charging devices for storage battery charging directly on vehicle without disconnecting battery terminals from vehicle circuits in following modes:

- rapid charging by increased current («boost» or similar modes);
- various START modes intended for engine starting

Never use starting and charging devices for engine starting with main battery disconnected or with inoperable main batteries connected (short circuits in banks, breakage of plates etc.)

Never use faulty charging devices, 24V charging devices and other power supply equipment (i.e. welding inverters), not dedicated to charge 12V vehicle batteries.

It is recommended do not use so named "light up" method for charging vehicle battery and start engine by connecting cables from a donor vehicle battery.

Owner is fully responsible for possible short circuit or surge voltage and damaging of security system and vehicle electronic components caused while using this method.



Follow a safe storage battery charging procedure!

Before charging a battery terminals shall be disconnected from vehicle circuits.

Then battery charging can be started. After charging, connect battery terminals back to vehicle circuits.

It is necessary due to impossibility of detecting main battery charge and health state without specific measuring equipment (i.e. internal short circuits or plates breaks).

Connecting a charging device to an inoperable storage battery may cause a risk of car electronic equipment and security system damage with increased over limit voltage.

General description

Security telematics system StarLine S9 V2 (hereinafter the system) is intended for vehicle securing against theft, immobilising and convenient remote control via cellular networks and location monitoring with use of global satellite positioning systems.

Depending on delivery set StarLine security system can be controlled with radio remote key, wireless radio tag and a smartphone with StarLine App.

Major benefits

- embedded buzzer for installer and owner notification;
- «Slave» mode to arm and disarm security systems with use of factory key or Keyless-go;
- driver authentication by wireless tag, paired smartphone via Bluetooth Smart or by PIN code entered with factory buttons (Pin-to-Drive);
- Anti-hijack mode by a tag loss in trip;
- short range radio control secured with Dialogue Code and 128 bit encryption keys, ensuring security against all existing code grabbers;
- embedded 2CAN+4LIN digital interface for easier integration with modern vehicles control circuits;
- control over vehicle statuses (battery voltage, fuel level etc.)
- remote and automatic engine start by preset temperature, timer, battery charge level;
- factory immobiliser bypass with external immobiliser bypass module or with embedded data immobiliser bypass via CAN, LIN interfaces;

- remote control over parking heaters and auxiliary heaters;
- data recording and storage a trip data in non-volatile memory (“black box”);
- universal programmable input and output channels;
- Flexible Logic for customized system operation in various individual scenarios;
- universal StarLine Master installer’s software for system configuration and updating.

Technical specification

Parameters	Values
Short range control	2.4GHz Bluetooth Low Energy
Middle range radio control range	868 MHz
Rated radio control distance	up to 1500 m
Rated radio notification distance	up to 2000 m
Interfaces	<ul style="list-style-type: none"> • 2x CAN • 4 x LIN • 1 x StarLine coded data bus • 1 x USB • 18 programmable channels which can be set as: <ul style="list-style-type: none"> • 15 OC negative outputs – 200 mA max • 2 positive outputs – 2 A max • 3 positive inputs • 3 negative inputs • 1 universal input • external temperature sensor input • external service (valet) button input • external microphone sensor input
Input voltage	8 – 16 V
Rated current	8,7 mA
Tag battery	CR2032 3V
Remote key battery	LR03 AAA 1.5V
Temperature range	-40 °C ... +85 °C
Main unit dimensions	105 x 63 x 16 mm
Main unit weight	63 g

Personal ID card

Delivery set includes an owner personal ID card containing following data:

- Login and password for StarLine personal account
- Emergency disarm code for instant security deactivation when regular disarming methods unavailable.
- Service code to enter main unit configuration parameters in StarLine Master software
- Main unit serial number

Login	Emergency disarm code
<input type="text"/>	<input type="text"/>
Password	Service (Valet) code
<input type="text"/>	<input type="text"/>
Login and password for access to starline.online private account, if GSM module available	
<input type="text"/>	<input type="text"/>



Remove the protection layer from plastic card carefully. Do not use metal and other sharp items to avoid occasional erasing a printed information under layer.



Do not tell emergency disarm code and StarLine account details to anybody!



Due to security reasons a personal information from ID card is generated randomly at factory, never stored in any database and therefore cannot be recovered once it is lost! A system main unit with lost Service code and Emergency disarm code cannot be

normally used and must be replaced to a new one. Recommend to copy and store ID card information in a safe place in reach.

StarLine.online service and mobile App (optional)

StarLine system can be remotely controlled and monitored with use of [starline.online](#) web monitoring platform and StarLine 2 mobile app with free of charge unlimited subscription.

This feature is available when E9v2 security system is paired with the optional StarLine M66 GSM GPS wireless communication (tracking) device via Bluetooth.

In this bundle login and password from M66 ID card is used to sign in StarLine account.

Without external M66 communication device E9 v2 system can be controlled by means of StarLine 2 mobile App via Bluetooth on a short distance from vehicle (up to 50 m approx).

Enter Login and Password from personal ID card to sign in StarLine 2 mobile app (available on Android and iOS platforms) to arm /disarm system and program settings.



Supported for smartphones with Bluetooth Low Energy 4.2 version and above.

To use Bluetooth communication make smartphone pairing in Accessories registration mode – see p.35. Then enable connection with paired device in StarLine App Bluetooth settings.



Do not remove device from StarLine 2 app factory account, when system is used without external communication device, as it cannot be registered again via Bluetooth!



Do not forget to enter and verify your email in personal StarLine account. Verified email is necessary to restore forgotten password, access sharing and other important functionality.

Lights and sound indication

Security system indicates its status by means of sounds (siren or buzzer) and lights (hazard or other lights).

● — short signal

▬ — long signal

Events	Lights	Sounds
Arming	●	●
Arming with one of secured zones breach	●●●●	●●●●
Arming with Hands free mode disabling	●	●▬
Arming with Hands free mode disabling and one of secured zones breach	●●●●	●●●●▬
Disarming	●●	●●
Disarming (one of secured zones breached in armed mode)	●●●	●●●
Disarming with Hands free mode disabling	—	●●▬
Alarm	30 cek	30 cek
Warn away alarm	●●●●●●	●●●
Panic	10 cek	10 cek
Trunk unlock	●	●
Anti-Hijack mode off	—	●●

LED service button indication

State of security system	LED light
Disarmed	Off
Disarmed with ignition On and one of secured zones breach (doors, hood, trunk)	1 flash per 5 sec
Armed	1 flash per 1 sec
Armed with Hands free mode active	2 flashes per 1 sec
Engine is running	continuous On
Service (valet) mode	Off
Immobiliser mode active	Off
Anti-Hijack mode active	10 in 1 sec
Invalid emergency disarm code entered	4 flashes
Emergency disarm code entry blocked for 15 min	5 flashes
Valid emergency disarm code entered	2 flashes

Embedded buzzer sound indication

Events	Sounds
Waiting for authorization	10 sec
Tag battery discharged (at ignition On)	● ● ●
Valid authorization PIN code entered	● ●
Invalid authorization PIN code entered	● ● ● ●

Control with wireless tag (transponder) (optional accessory)



Wireless tags availability depends on delivery set.

The included and optional tags are supplied from factory in transport (power saving) mode, i.e. inactive! Pushing a tag button in this mode is indicated by green and red alternating flashes of the built-in LED. To switch it to normal mode push a tag button several times until flashing color turns to green.

Connection check

Push button once to check tag connection status. 2 LED flashes means connection with security main unit established, 1 flash means disconnected. A flash color corresponds to the current active mode:

- green – Regular mode, Anti-hijack is disabled
- red – Anti-hijack mode is enabled
- yellow – Service mode is enabled

Control over security system

Duration of a tag button pushing:

- short – push and release button, followed with a flash of corresponding current operation mode;
- long – push and hold button until LED begins flashing.

Duration of long push are of 2 levels:

- 1 level – push and hold button followed with double short flashes of a current operating mode and then long flash at which button must be released;
- 2 level – push and hold the tag button followed with double short flashes of a current operating mode, then one long flash and then followed with serial flashes at which button must be released.

Command	Button push
Arm / disarm	1 short
Enable / disable Anti-hijack by a tag away	long 1 level
Enable / disable Service mode	long 2 level

Replacing a tag battery

Wireless tag (transponder) is equipped with CR2032 type Li-ion battery.

i Tag battery discharging is indicated with 3 sounds of embedded main unit buzzer (or siren) at ignition On. Then battery must be replaced as soon as possible.

To replace battery open a tag casing carefully with a flat metal or plastic item, remove discharged battery from slot. Install a new battery in the slot observing correct polarity (positive side up, as shown on picture). Then fix a cover back. Tag is ready for operation.



A smartphone with support of Bluetooth 4.2 and above can also be used as a tag.

See Devices registration article to pair a smartphone as a tag.

Control with 2-way remote key (optional accessory)









LCD remote control and matching external RF868 transceiver are optional accessories and can be ordered from local dealer.

Display icons meaning





Remote engine start

Icons	Meaning
	Engine is running
	Automatic engine start by timer enabled
	Periodic automatic engine start enabled
	Automatic engine start by temperature enabled
	Automatic engine start by battery voltage drop enabled
N	Program neutral executed
	Parking heater activated (blinking)





Operating modes



Icons	Meaning
	Armed
	Hands Free mode
	Service mode
	Programming mode
	Buttons lock
	Anti-Hijack mode

Secured zones





Icons	Meaning
	Ignition switched On
	Parking brake tighten
	Hood open
	Door open
	Trunk open

Sensors

Icons	Meaning
	Motion or tilt sensors triggered
	Auxiliary sensor 1 triggered
	Auxiliary sensor 2 triggered
	Tilt sensor triggered
	Motion sensor triggered

	Shock sensor warning level triggered
	Shock sensor main level triggered
	Shock sensor disabled



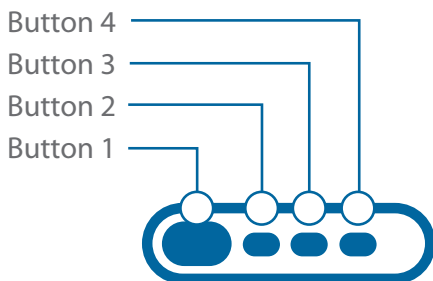

Additional indicators

Icons	Meaning
	Data transfer
	Replace remote battery
	Siren sounds enabled
	Siren sounds disabled

Control commands













































Definition of buttons push duration:

Short push	Pushing one or two buttons once less than 1,5 sec. Example: 1 — first button short push; 2 3 — short push of first and second buttons simultaneously.
Long push	Pushing and holding a button or two buttons until melody and vibration come up. 2 levels of a long pushing are envisaged: • 1 level long push – push and hold until a first melody. Example: 1  — 1 button long push; 1 2  — 1 and 2 buttons long push simultaneously; • 2 level long push — push and hold until a second melody; Example: 4  — 4 button long push of a 2 level.
Double push	Double push of one button within 1 sec. Example: 1 1 — double push of 1 button.
Triple push	Triple push of one button button within 1 sec. Example: 1 1 1 — triple push of 1 button.
Sequential push	Double push of one or two buttons with different duration. First pushing is long (1 or 2 level) and second push is short. First button must be released before pushing next button. Example: 2  1 — sequential pushing 2 and 1 buttons.



Control commands

Commands	Buttons combination
Arm	1
Silent arming	1 1 1
Disarm	2
Silent disarming	2 2 2
Request vehicle statuses (engine and cabin temperature, battery voltage, fuel level). At remote start – remaining engine run time.	3
Start engine	1 

Stop engine	 
Start parking heater	  
Stop parking heater	  
Find car on parking	
Switch shock sensor On / Off	  
Switch motion / tilt sensor On / Off	  
Enable Panic	 
Unlock trunk	 
Enable automatic engine start	configuration menu
Enable / disable Service mode	  or configuration menu
Enable / disable Hands free mode	configuration menu
Enable / disable buttons lock	 
Enable / disable auto buttons lock	  
Enable vibration only	  
Enable sound profile 2	  
Enable sound profile 1	  
Enable sound profile 0	  
Enable sound profile --	  
Activate Flexible Logic program	 

Modes menu







Some options and operation modes are controlled in Modes menu: Hands Free mode, Service mode, Autostart settings.

Modes menu is entered and exited with 4 button long push level 1:  . Modes menu is automatically exited when no any buttons pushed 15 sec.

Modes submenu is flipped with **1** and **4** buttons short push forward and backward accordingly. Submenu options are selected with 2 and 3 buttons short push: **2****3**. Parameters are tuned with **2** and **3** buttons short push up and down accordingly.

Long buttons pushing increases parameters tuning speed.

Listing menu points, changing settings and menu exit are confirmed with melody.

Icons	Parameters	Description	Tune step
	Hands Free mode	Enable / disable Hands Free mode	—
	Automatic engine and parking heater start by timer	Set engine start hour and min. Engine and parking heater autostart settings are switched with short pushing buttons 1 2 and 3 4 . Engine start settings are indicated with digit 1, parking heater settings – with digit 2.	1 min
	Periodic engine start	Set engine start interval in hours	1 hour
	Automatic engine start by temperature	Set engine start temperature in Celsius degrees	1 °C
	Automatic engine start by battery voltage	Set main storage battery voltage limit in Volts	0,1 V
	Service mode	Enable / disable service mode	—

Time and date setup

1. Enter time setup menu with sequential pushing button: **4**  **4**.
2. Set current time hours with **2** button and minutes with **3** button.

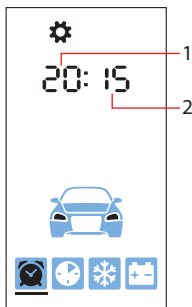

- 1 – hours
- 2 – minutes

3. Push **1** button to turn to current date setting.

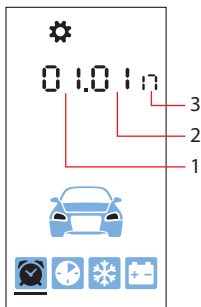

- 1 – date
- 2 – month
- 3 – year

4. Set current date with **2** button, current month with **3** button and year with **4** button.

5. Push **23** buttons together to exit from time setup menu.

Main settings menu

Operation parameters are set in the Setting menu.

Settings menu is entered and exited with 4 button long push level 2:

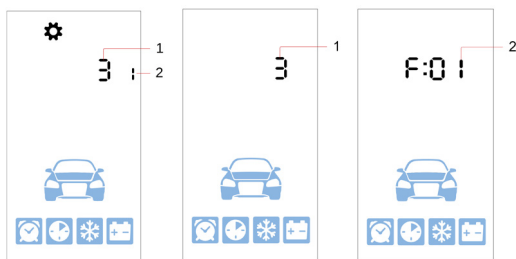

1 – parameter function number

2 – parameter value

Operation menu points are flipped with **1** and **4** buttons up and down accordingly.

Parameters are tuned with **2** and **3** buttons short push up and down accordingly.

Long buttons pushing increases parameters tuning speed.

Listing menu points, changing settings and menu exit are confirmed with melody.

Time zone setup

Select 1 item of Settings menu and set matching time zone with **2** and **3** buttons.



Current time is automatically retrieved from cellular network and satellites data (if GPS module is available).

Setting lights and siren indication at Arming and Disarming

Select 2 item of Settings menu and set the mode with **2** and **3** buttons:

- 0 – hidden mode without siren and lights indication
- 1 – silent mode with lights indication only
- 2 – full mode with siren and lights indication
- 3 – only siren indication

Setting siren volume at Arming and Disarming

Select 3 item of Settings menu and set siren volume level with **2** and **3** buttons:

- 0 – silent mode, 10 – max volume

Setting lights and siren indication in Alarm mode

Select 4 item of Settings menu and set the mode with **2** and **3** buttons:

- 0 – hidden mode without lights and siren indication
- 1 – silent mode with lights indication only
- 2 – full mode with lights and siren indication

Setting siren volume setup in Alarm mode

Select 5 item of Settings menu and set siren volume level with **2** and **3** buttons:

- 0 – silent mode, 10 – max volume

Setting motion sensor sensitivity

Select 6 item of Settings menu and set sensor sensitivity from 0 to 30 level with **2** and **3** buttons:

0 – motion sensor is disabled, 30 – max sensitivity

Setting tilt sensor sensitivity

Select 7 item of Settings menu and set sensor sensitivity from 0 to 30 level with **2** and **3** buttons:

0 – tilt sensor is disabled, 30 – max sensitivity

Setting shock sensor warning level sensitivity

Select 8 item of Settings menu and set sensor sensitivity from 0 to 30 level with **2** and **3** buttons:

0 – warning level shock sensor is disabled, 30 – max sensitivity

The warning shock sensor sensitivity must be set over the main shock sensor level.

Setting shock sensor main alarm level sensitivity

Select 9 item of Settings menu and set sensor sensitivity from 0 to 30 level with **2** and **3** buttons:

0 – main alarm shock sensor is disabled, 30 – max sensitivity

The main alarm shock sensor sensitivity must be set below the warning shock sensor level.

Setting tag (transponder) loss range

Select 10 item of Settings menu and set tag loss range value from 3 to 10 level with **2** and **3** buttons:

0 – min distance, 10 – max distance

Setting tag (transponder) detection range

Select 11 item of Settings menu and set tag detection range value from 1 to 8 level with **2** and **3** buttons:

1 – min distance, 8 – max distance



Tag detection range must be set less than a tag loss range.

Setting remote key connection control

Select 12 item of Settings menu and set connection control period to 1 or 2 value with **2** and **3** buttons:

0 – connection control is disabled, 1 – connection check every 3 min

Setting turbotimer run time

Select 13 item of Settings menu and set turbotimer run time from 1 to 5 min with **2** and **3** buttons.



Remote engine start must be enabled in system configuration parameters for this option.

Setting remote / automatic engine start duration

Select 14 item of Settings menu and set engine run time from 10 to 60 min with **2** and **3** buttons.

Setting max duration of extended remote / automatic engine start

Select 15 item of Settings menu and set extended engine run time from 15 to 60 min with **2** and **3** buttons.

Setting parking heater starting max duration

Select 16 item of Settings menu and set max parking heater starting interval from 1 to 10 min with **2** and **3** buttons.

Setting parking heater run time duration

Select 17 item of Settings menu and set parking heater run time from 5 to 60 min with **2** and **3** buttons.

Setting parking heater activation before remote engine start

Select 18 item of Settings menu and set parking heater activation before remote engine start with **2** and **3** buttons:

0 – do not start parking heater

1 - start parking heater before remote engine start

Setting parking heater activation before automatic engine start

Select 19 item of Settings menu and set parking heater activation before automatic engine start with **2** and **3** buttons:

0 – do not start parking heater

1 - start parking heater before automatic engine start

Setting temperature for parking heater activation before remote and automatic engine start

Select 20 item of Settings menu and set parking heater activation temperature before remote and automatic engine start from -5 to -30 °C with **2** and **3** buttons.

Setting temperature for automatic engine start

Select 21 item of Settings menu and set automatic engine start temperature from +10 to – 40 °C with **2** and **3** buttons.









Setting 2 way remote key detection range

Select 22 item of Settings menu and set remote key detection range from 1 to 10 level with **2** and **3** buttons:

1 – min distance, 10 – max distance

Sound profile menu

Sound profiles menu contains settings for commands confirmation, alarm trigger and buttons pushing. Profiles are selected with following buttons combination:



Nº	Profile	Button combination	Description (at default settings)
1	SOUND 2	  1	All signals at max level and vibration enabled.
2	SOUND 1	  2	All signals at min level and vibration enabled.
3	SOUND 0	  3	Vibration only, all sounds Off
4	SOUND –	  4	Fully silent, vibration and all sounds Off

Changing sound profile settings

Sound profile menu is entered with   long pushing level 2.

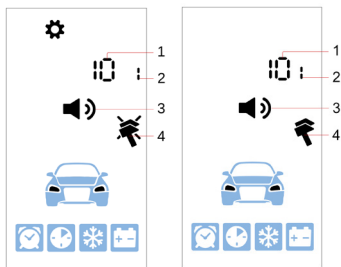
Setting commands confirmation signals



- 1 — selected signal type volume level
 2 — selected sound profile number
 3 — commands confirmation sound settings icon
 4 — vibration:  — enabled,  — disabled

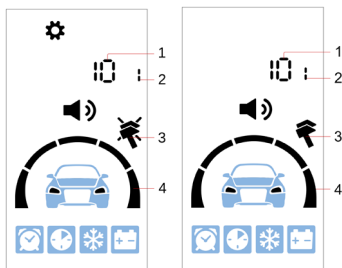

Sounds volume is tuned with **2** and **3** buttons short push.
 Vibration is enabled and disabled with **4** button short push.
 Next sound signal type is flipped with **1** button short push.

Setting alarm sounds volume



1 — selected signal type volume level

2 — selected sound profile number

3 — vibration:  — enabled,  — disabled

4 — alarm sounds volume settings icon

Sounds volume is tuned with **2** and **3** buttons short push.

Vibration is enabled and disabled with **4** button short push.

Next sound signal type is flipped with **1** button short push.

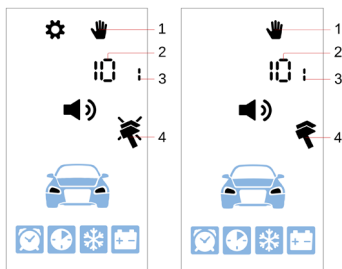

Setting buttons push sound volume



1 — buttons sound volume setting icon

2 — selected volume

3 — selected sound profile

4 — vibration:  — enabled,  — disabled

Sounds volume is tuned with **2** and **3** buttons short push.

Vibration is enabled and disabled with **4** button short push.



Next sound signal type is flipped with **1** button short push.

Sound profile settings menu is automatically exited in 10 sec if no any buttons pushed.

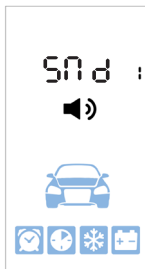
After exit the set sound profile is indicated for several sec.



Resetting sound profile to factory default settings

1. Select the necessary sound profile with corresponding buttons combination.
2. Enter sounds profile menu with **3**  long pushing level 2
3. Hold 3 button until next sound signal **3** .

Setting sounds tone

The sounds tone can be also setup in sounds profile menu.

1. Enter to sounds profile menu with **3**  long pushing level 2
2. Push buttons **23** shortly. The current sounds tone St-1 or St-2 shall be displayed. St-1 tone is set as default.

3. Push buttons **23** shortly to select next tone.

Sounds tone menu is automatically exited in 10 sec if no any buttons pushed.

Buttons auto lock

The option lock buttons automatically each time after backlit off.

It is enabled and disabled with **14**  long push level 2.

Remote key searching

Push and hold service (valet) button for 5 sec – remote key shall beep.

Operation modes

Security modes	Armed
	Disarmed
	Anti-hijack
	Alarm
	Panic
Supplementary modes	Slave
	Hands Free
	Service mode
	Registration
	Configuration

Armed mode

The following zones are controlled in armed mode: ignition, doors, trunk, hood, shock sensor, tilt sensor, motion sensor, auxiliary sensor. If any zone is breached then system shall trigger alarm.



System can be armed when ignition off only. If arming command received at ignition on, then only doors are locked.

System is armed by one of following ways:

- pushing tag button once shortly
- pushing remote key **1** button shortly
- command from StarLine mobile app
- arming with factory security system in «Slave»
- tag loss or touching capacitive sensor in Hands Free mode.

System shall confirm arming with 1 lights flash and 1 siren sound.



If any of doors, hood, trunk are still open then system shall warn thereof by 4 siren sounds and 4 light flashes. Shut the breached zone and make sure that 1 light and sound of arming confirmation followed.

Silent arming

System can be armed silently without siren sound confirmation with triple pushing remote key button **1 1 1**

Silent arming is confirmed with 1 lights flash.

Emergency arming

In case of a tag, remote key batteries discharged and other methods of arming not available, then system can be armed with following way:

1. Push service button or external transceiver button 3 times.
2. Switch ignition On. 3 beeps will follow.
3. Make sure next 2 beeps come up.
4. Switch ignition Off.
5. Leave vehicle and shut the doors.

Disarmed mode

System is disarmed by one of following ways:

- short push of remote key **2** button

- command from StarLine mobile app
- disarming factory security system (Slave)
- tag detection or holding capacitive sensor in Hands Free mode

Disarming is confirmed with 2 siren sounds and 2 lights flashed. If alarm was triggered while armed mode then 3 siren sounds and 3 lights flashes come up at disarming.

All events happened in armed mode will be indicated on remote key display after disarming.



If no any actions taken after disarming (i.e. doors, trunk were not open), then system shall automatically turn to armed mode back and lock the doors (Re-arming).

Automatic doors locking on a trip

System can make automatic doors locking on a trip at one of following selected terms:

- ignition is switched On
- vehicle starts moving and brake pedal pressed
- parking brake released
- automatic transmission is shifted from parking position
- preset vehicle speed is reached

Automatic doors unlocking on a trip

System can make automatic doors unlocking on a trip at one of following selected terms:

- ignition is switched Off
- automatic transmission is shifted to parking position
- engine is stopped
- ignition is switched Off and automatic transmission is shifted to parking positioning
- parking brake is tighten



Automatic doors lock / unlock option can be enabled and configured in StarLine mobile app or starline.online account.

Trunk unlock in armed mode

If this option is enabled in system configuration then owner can unlock and open trunk by means of a factory remote / trunk lid button in armed mode once StarLine tag is visible in detection range.

Blocking factory Keyless-Go system

The option of factory Keyless-Go blocking via CAN bus brings higher level security as it secures against factory key stealing and relay attack with specific radio hacking devices. The system shall lock factory Keyless-Go system once StarLine tag is away of detection range. And then unlocks it once tag is detected again in range.



This option is disabled in default settings and must be enabled in system configuration. Owner authorization with tag must be enabled for this option operation. Find out if the option is supported for your vehicle via CAN bus at can.starline.ru

Alarm mode

Alarm shall trigger when any of secured zones is breached in armed mode. System activates siren alert sound, hazards lights flashing for 30 seconds. If breached zone is not restored system repeats alert cycle once again.

Any warning zone breaching is followed with 3 lights flashes and 3 siren sounds.

Alarm mode can be aborted with short push of a tag button and **1** or **2** remote key buttons.



The maximum number of zone triggering is limited to 8 times within 1 security cycle.

Panic mode

Panic mode ensures owner and vehicle security and informs on intrusion attempt.

Mode can be activated with double pushing **1 1** remote key button.

System shall activate siren alert and hazard lights flashing for 10 sec in order to scare an intruder and attract other people attention.

Anti-hijack mode

Anti-hijack mode secures driver against assault attempts on trip. The mode is activated either by a tag or remote key loss on a trip.

The mode can be activated by a tag button long push level 1, if it is enabled in system configuration settings.

Anti-hijack operation algorithm depends on a vehicle speed reading from CAN bus.

1. Anti-hijack operation sequence when speed supported from CAN bus:
 - any of secured zones has been breached (doors, hood or trunk)
 - motions sensor has triggered
 - in 30 sec system begins seeking for a tag or remote key
 - in another 30 sec, if a tag or remote key has not been detected, system enables warning sound and lights for 10 sec
 - by reaching a speed below 30 km/h engine will be safely stopped.

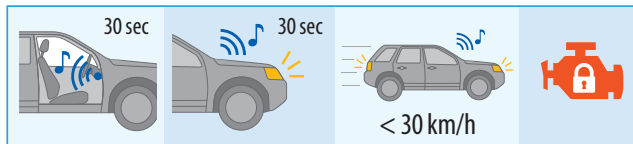

2. Anti-hijack operation sequence when speed from CAN bus is not supported:

- any of secured zones has been breached (doors, hood or trunk)
- motions sensor has triggered
- in 30 sec system begins seeking for a tag or remote key
- in another 30 sec, if a tag or remote key has not been detected, system enables warning sound and lights for 10 sec
- engine will be stopped in 3 min or at brake pedal pressing.

Exit from Anti-hijack mode by a tag or remote key loss is made by one of following ways:

- when tag or remote key is detected in range
- entering emergency disarm code with service button or external transceiver button



In case of invalid emergency disarm code is entered 3 times, then a code entry will be blocked for 15 min.

Slave mode

Slave mode allows to control security system by means of a factory remote control or Keyless-Go system.

System detects unlocking doors and disarming factory security and waits for owner authorization with any of below methods before disarming itself:



Waiting for authorization starts at any of door, hood and trunk open.

- tag or remote key detection in range at disarming during adjusted interval from 15 to 60 sec
- entering personal PIN code with factory buttons at ignition On during adjusted interval from 15 to 60 sec

If authorization failed by any of methods then system shall activate warning siren sounds and then turn to alarm mode.



It is highly recommended to enable above mentioned secondary owner authorization methods in Slave mode in system configuration settings.

Hands free mode

Hands free mode allows automatic system arming and disarming by a tag loss and detection in range.

The mode can be enabled and disabled in remote key operation modes menu.

In this mode system is armed either by a tag loss from range or with holding door sensor (optional accessory) with a tag in range.

Systems is disarmed by a tag detection in range or with touching door sensor (optional accessory) with a tag in range.

If any of door, hood or trunk left open when tag is away, then system shall inform owner with siren alert on arming abort.

Once a breached zone restored, system shall turn armed.

If tag is lost on a trip (i.e. battery critically discharged) then system shall turn armed mode in 10 sec after any door open (auto arming).



Auto arming is not executed in Hands Free mode when tag is in range.

Disabling Hands Free mode for 1 security cycle

When tag is within detection range at a parking place, then it is recommended to disable arming and disarming in Hands Free mode for 1 security cycle.

- Hands Free is enabled / disabled for 1 cycle in one of following ways depending on current state (disarmed / armed) accordingly:
- arming / disarming with a tag button accordingly
- arming / disarming with remote key button 1 and 2

System shall confirm successful disabling Hands Free for once cycle with 1 sound.

System shall return to default Hands Free in following ways depending on current state (disarmed / armed) accordingly:

- disarming and any of door, hood or trunk open
- switching ignition On or arming command received

Service (Valet) mode

Service mode is used for temporary security deactivation and restricting access to system configuration while vehicle maintenance, car wash etc. Service mode can be activated from disarmed state only.

In service mode following features are disabled:

- arming and disarming
- Hands Free mode
- doors lock and unlock in trip
- remote and automatic engine start
- turbotimer
- trunk unlock
- arming with open trunk with factory remote
- Panic
- Anti-hijack by a tag or remote key loss

- entry to system configuration settings
- entry to registration mode

Service mode is enabled by any of following ways:

- tag button long push level 1 (if this option is enabled in system configuration)
- short push of remote key buttons
- in remote key operation modes menu

Service mode activation is confirmed with a tag LED light turned yellow.

Service mode is disabled in one of following ways:

- tag button long push level 1 (if this option is enabled in system configuration)
- short push of remote key buttons
- in remote key operation modes menu
- emergency disarm code entry

Automatic exit from service mode

If this option is enabled in system configuration then system automatically turns from Service mode to Waiting for authorization at configured event and ignition On. If authorization successfully passed then system turns to Disarmed. If authorization failed then system triggers Alarm and activates engine blocking.



This option requires owner authorization, embedded sensors and vehicle speed from CAN bus to be enabled in system configuration.

Immobilizer mode

Immobilizer mode prohibits unauthorized drive attempt.

Depending on settings system waits for owner authorization with a tag or remote in detection range or PIN code entered with factory buttons

after every disarming or every ignition switching Off and at next ignition switching On.

PIN code can be entered with factory buttons only when ignition is switched On.

If authorization is not passed within 1 min, then engine will be stopped at a drive attempt for 1 min or until successful authorization passed.

Remote engine start

The feature allows to make remote and automatic engine start and stop to warm up or cool down vehicle interior to a comfortable temperature and warm up engine before a trip.

Preparation of a vehicle with manual transmission for remote and automatic engine start.

If vehicle is equipped with manual transmission, then system must be set to **"Program neutral"** state to prepare for further safe remote or automatic engine start in following procedure:

- tighten parking brake at engine running
- remove key from ignition barrel, engine continues running, service button LED will light up permanently
- leave vehicle, shut doors, hood, trunk and arm security system. Engine will be stopped.
- system turns to Armed
- "N" (program neutral) icon is indicated on remote key display and StarLine app main screen
- system and vehicle are now ready for remote and automatic engine start.





If any door is open or ignition is switched On after setting to Program neutral, then remote and automatic engine start will be prohibited until Program neutral procedure is executed again.

Vehicle equipped with automatic transmission must be switched to **Parking position** in order to prepare it for remote or automatic engine start.

Engine start

Remote engine start can be activated by one of following ways:

- tag button short push once (if enabled in system configuration)
- long push level 1 of remote key button  
- 3 x Lock command from factory remote control (if supported for particular vehicle model and enabled in system configuration)

Automatic engine start can be activated by following terms:

- engine or interior temperature
- main vehicle battery voltage drop
- periodic engine start set in hours
- engine start by timer

Parameters for automatic engine start can be configured in:



- remote key operation modes menu
- StarLine mobile app



Automatic engine start is allowed only in armed mode, in 5 min after last engine stop and 1 hour after previous remote and automatic engine start.

Engine stop

Engine will be stopped when:

- tag button short push once (if enabled in system configuration)
- long push level 1 of remote key button  ;
- SMS text command 20
- alarm mode triggered
- vehicle motion detected
- hood open

- parking brake released (for manual transmission)
- automatic transmission is shifted out of parking position
- brake pedal pressed
- preset max engine temperature limit reached

Drive after remote start without engine stop (ignition takeover)

To start driving after remote / automatic engine start without engine stop make following depending on engine control system:

- **for vehicles with ignition barrel:**
 - disarm security system
 - insert key into ignition barrel and turn it to ignition On
 - start driving
- **for vehicles with PTS (push-to-start) button:**

Option 1:

- disarm security system
- press and hold brake pedal for 3 sec

Option 2:

- disarm security system
- push PTS button 1 or 2 times



Learn ignition takeover support and particular procedure from your StarLine installer.

Parking heater (preheater) control

This feature lets warm up engine and/ or interior before a trip with remote and automatic activating parking heater and auxiliary heater.

Parking heater can be started manually by sequential pushing remote key buttons **2**  **1**.





Default parking heater run time at manual activation is 20 min and can be adjusted in system configuration.



Factory and optional parking heater may have embedded primary factory settings, differ from those configured in system settings.

Parking heater run time can be extended with sending repeated activation command.

Parking heater can be stopped manually by sequential pushing remote key buttons  ;

Parking heater can be automatically started before remote and automatic engine start on events and terms set in system configuration.

Parking heater can be started automatically in following terms:

- by engine temperature – parking heater is started when engine temperature is below the set value
- by timer – parking heater is started at a set time

Temperature and time for parking heater activation can be set in:

- remote key operation mode menu
- StarLine mobile app

Parking heater is stopped when the set engine start temperature (for automatic engine start) or the set parking heater run time is reached and engine will be started then.

Default parking heater automatic run time is 20 min. It can be extended by sending heater start command again.

Intelligent turbotimer

Turbotimer option is used to temporary continue engine running after a trip to cool down turbo charger and extend its lifetime.



The option must be initially enabled and programmed while installation.

Turbotimer activation on vehicles with ignition barrel:

- tighten parking brake at engine running. The service button LED shall light up permanently;
- take a key out of ignition barrel. Engine shall keep on running.
- leave a vehicle, shut doors, trunk, hood and arm security system;
- engine shall stop after interval sufficient for cooling down a turbine.

Turbotimer activation on vehicles with Push-to-Start button:

- tighten parking brake at engine running;
- leave a vehicle, shut door, trunk, hood and arm security system;
- engine shall stop after interval sufficient for cooling down a turbine.



Turbine cool down interval is calculated automatically and depends on engine speed before a trip finished. Max turbine cool down interval is 5 min.

Beach mode

In Beach mode system is armed and disarmed without a tag and remote key, which can be left inside vehicle. System is disarmed by owner authorization with emergency disarm code entered by means of StarLine EC-1 touch sensor installed in a door handle or another convenient place (under plastic parts). System does not execute any commands from remote key in this mode.

Beach mode activation procedure:

1. Disarm security system and switch ignition Off.
2. Push service button or external transceiver button 3 times and switch ignition On. 3 sounds confirming entry to Beach mode shall follow. Switch ignition Off.
3. Leave vehicle and touch door handle sensor 3 times. System shall turn armed.



Hands Free mode is switched Off in Beach mode until disarming.

Disarming (exit from Beach mode) is done by entering emergency disarm code by means of touch sensor with less than 3 sec intervals. Every valid digit entry is confirmed with sounds and flashes in corresponding number. Full valid code entry is confirmed with double sounds and flashes.



If invalid emergency disarm code is entered 3 times, then next code entry will be blocked for 15 min.



If nothing is done after disarming with emergency disarm code, then system shall return to armed and Beach mode remains active.

Video recorder (dashcam) control



The option must be initially wired and programmed while installation.

System can automatically switch dashcam On to begin recording:

- at ignition switched On – dashcam is activated for 5 min;
- at full alarm or warn alarm triggered – dashcam is activated for 2 min.



If engine is still running in armed mode then dashcam continues operating until engine is stopped.

Risky parking

This mode can be used in places with high probability of theft and robbery. In Risky parking mode system shall require owner authorization with factory buttons at every switching ignition On in disarmed mode. This mode operates regardless immobilizer mode

settings made in system configuration.

Risky parking activation:

1. Disarm security system
2. Switch ignition Off
3. Push service button or external transceiver button twice
4. Switch ignition On. Double sounds shall follow.

Risky parking activation is confirmed with 1 sound and flash, deactivation – with double sounds and flashes.

Accessories registration

Registration mode is used to pair new remote keys, tags, smartphones and other wireless and wired accessories into the system main unit.



To prevent unauthorized registration of new accessories, entry to registration mode is permitted in Disarmed mode only. If Immobilizer mode enabled then authorization must be passed to fully disarm a system.



Tags and smartphones shall be registered in one registration cycle. All previously paired tags and smartphones will be deleted from memory if not paired again together with the new ones.



Total amount of accessories can be registered in the system main unit:

- 5 wireless tags
- 4 smartphones
- 4 remote keys
- 4 service relay modules
- 8 wireless sensors



Total up to 8 Bluetooth accessories can be operated simultaneously, where: 1 memory cell is always reserved for registered smartphone or M66 tracking device, 7 cells are reserved for other wireless devices (tags, wireless relays and sensors). Once 8 first detected Bluetooth accessories are in range, then remaining registered Bluetooth accessories will be ignored until any of first devices get out of range.

Entry to accessories registration

1) Disarm system if it is armed.



2) Switch ignition off (if it is on).

3) Push service button or external transceiver button 7 times.



4) Switch ignition On. 7 LED flashes and 7 beep sounds shall follow.



5) Entry to registration mode will be confirmed with 2 LED flashes and 2 beep sounds.



Wireless tags (transponders) registration

1) Remove battery from a tag slot.

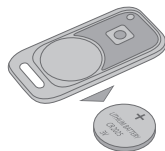

2) Push and hold tag button and insert battery back in slot observing the right polarity ("+" side top). The tag LED will light up red.

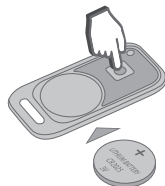

3) Release button and make sure a tag LED serial red flashes come up for 10 seconds..



4) Successful registration will be confirmed by a tag LED green flash, 2 service button LED flashes and 2 beep sounds. If a tag pairing failed then its LED will light up red.



5) Repeat items 1-3 for remaining tags.

Smartphone registration

1. Enable Bluetooth in smartphone and activate device searching
2. Select "StarLine E96" in available devices list
3. Enter pairing code 000000 (for iOS click "Pair")

Remote key registration

1. Push 1 and 2 remote key buttons shortly

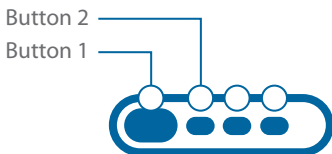

2. In 3 sec successful registration will be confirmed with remote key short beep, 2 service button LED flashes and 2 sounds.

If registration failed, then 4 beep sounds will follow.

3. Repeat items 1, 2 for remaining remote keys.

Exit from registration mode

System will automatically exit from accessories registration mode in 5 minutes or at ignition switch Off.

Exit from registration mode is confirmed with 2 service button LED flashes, 2 sounds and followed with a serial sounds in a number of total registered accessories.



Owner authorization code (PIN-to-Drive)

Pin-to-Drive code entered with factory buttons is used for secondary owner authorization at disarming and immobilizer mode.

Recording and changing authorization PIN code in registration mode:

1) Disarm system if it is armed.



2) Switch ignition Off if it is On.



3) Push service button or external transceiver button 7 times.

Press
7 times



4) Switch ignition On. 7 LED flashes and 7 beep sounds shall follow.

On

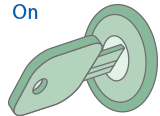

5) Entry into registration mode will be confirmed with 2 LED flashes and 2 beep sounds.

2 times



6) Enter a new PIN code with use of supported factory buttons with 3 sec and less intervals. Each pushing will be indicated with one LED flash.

Press the standard
car buttons





Authorization PIN code may consist of 2 to 25 push sequence of factory buttons. List of supported factory buttons is published at can.starline.ru for each supported vehicle. If pushing a button is not indicated with a LED flash, then this button is not supported via CAN bus.

- 7) Code entry will be confirmed in 3 sec with 2 LED flashes and 2 beep sounds.



- 8) Enter a new PIN code once again.

- 9) Properly repeated new code entry will be confirmed with 2 LED flashes and 2 beep sounds. Invalid code entry is followed with 4 LED flashes and 4 sounds, then repeat 5...8 steps.



- 10) Switch ignition Off within 10 sec to exit registration mode.

In 10 s
switch off.



- 11) Exit from registration mode will be confirmed with 2 LED flashes and 2 beep sounds.



Deleting authorization PIN code

1. Disarm system if it is armed



2. Switch ignition Off if it is On



3. Push service button or external transceiver button 7 times.

Press
7 times



4. Switch ignition On. 7 LED flashes and 7 beep sounds shall follow.

On

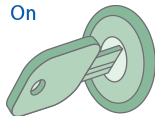

5. Entry into registration mode will be confirmed with 2 LED flashes and 2 sounds.

2 times



6. Push service button 3 times.

7. Wait for the long LED light up confirming that existing authorization PIN code has been erased from memory.

8. Switch ignition Off.

9. Exit from registration mode will be confirmed with 2 LED flashes and 2 beep sounds.

Emergency disarming

System can be fully disarmed with emergency disarm code, indicated on owner ID card, when:

- tag is lost
- tag or remote key battery discharged
- Anti-hijack mode activated

Login

Code of emergency security deactivation

Password

Service code

The login and password for entering the personal account on the website www.starline-online.ru

Technical support phone, toll free in Russia: 8-800-333-80-30

Emergency disarming with service button

1) Make sure ignition is switched On.



2) Push service button or external transceiver button a number of times, equal to the first digit of emergency disarm code.

Push
X times



X - first digit of
emergency disarm
code

3) Each digit entry will be confirmed within 3 sec with service button LED flashes in a number equal to a sequence number of corresponding digit entered (1,2, 3 or 4 times).

X times



4) Repeat 1...2 steps for remaining digits.

5) Valid code entry is confirmed with 3 flashes and 3 sounds, system turns disarm.



If invalid emergency disarm code is entered 3 times, then next entry shall be blocked for 15 min. Each button push in this interval will be indicated with 5 flashes.

Example of entry the code 5342

	on	off	off	on	off	on	off
Ignition							
Press the service button		5 times		3 times		4 times	
Flashes of the service button			1 time		23 times		times

	on	off	on
Ignition			
Press the service button		2 times	
Flashes of the service button		4 times	3 times

Changing emergency disarm code with service button (or external transceiver button)

1. Switch system in disarmed mode if it is armed.
2. Push service button 4 times.
3. Switch ignition On. 4 LED flashes and 4 sounds shall follow.
4. Entry into code recording will be confirmed with 2 LED flashes and 2 sounds.





If nothing is done withing 5 sec system shall turn Off emergency code recording mode.

5. Switch ignition Off.
6. Switch ignition On and push service button a number of times equal to a first digit of **existing** emergency disarm code.
7. Switch ignition Off. Each digit entry will be confirmed with LED flashes equal to a sequence number of corresponding digit entered (1,2, 3 or 4 times).
8. Repeat 6...7 steps for remaining digits.
9. Valid existing code entry will be confirmed with 2 LED flashes and 2 beep sounds.
10. Switch ignition On. Push service button a number of times equal to a first digit of **a new** emergency disarm code.
11. Switch ignition Off. Each digit entry will be confirmed with LED flashes equal to a sequence number of corresponding digit entered (1,2, 3 or 4 times).
12. Repeat 10...12 steps for remaining new code digits.
13. A new code entry will be confirmed with 2 LED flashes and 2 beep sounds.
14. Enter a new code once again repeating 10...12 steps.
15. New emergency disarm code recording will be confirmed with 2 LED flashes and 2 beep sounds.

Optional accessories

	<p>BT-6 wireless tag (transponder)</p> <p>Short range 1-way remote control on a distance 10-15 m approx Radio operation range – 2.4 GHz Bluetooth Low Energy Button for arming / disarming / switching operation mode / engine start / stop LED indicator Built-in accelerometer Battery CR2032 3V Waterproof shockproof casing</p>
	<p>2-way LCD remote key</p> <p>2-way radio remote control on a distance up to 2000 m Radio operation range – 868 MHz 4 control buttons (see functions in instruction manual) LCD display Built-in buzzer and vibration drive Battery LR03 (AAA) 1.5V</p>
	<p>M66 tracking device</p> <p>Can be paired to E9 V2 main unit via Bluetooth as external GSM GPS communication and tracking module Radio operation range – 2.4 GHz Bluetooth Low Energy Built-in LED and button Built-in CAN bus interface Ignition input Engine blocking output microUSB port for programming</p>

 A black rectangular sensor with a small black plastic button on top. It has several colored wires (red, green, blue, yellow) extending from the bottom. A small black label with white text "StarLine EC-1" is attached to the top.	<p>EC-1 touch sensor</p> <p>Capacitive sensor to perform Hands Free functionality by touching a door handle when tag is in range and emergency disarm code entry in Beach mode.</p>
 A black rectangular sensor with a small circular LED and a button on top. It has a small black rectangular reed switch component attached to the side. The "StarLine" logo is visible on the front.	<p>MS-06BT wireless sensor</p> <p>Wireless sensor with reed switch to secure camper, van doors, windows, roof racks etc. Radio operation range – 2.4 GHz Bluetooth Low Energy Built-in LED and button Built-in accelerometer and temperature sensor Battery CR2450 3V</p>
 A black cylindrical module with a "StarLine" logo on the side. It has several colored wires (red, green, blue, yellow) extending from one end.	<p>R6 wireless service module</p> <p>Wireless service module for engine blocking, siren and hood lock control Radio operation range – 2.4 GHz Bluetooth Low Energy Built-in accelerometer Built-in relays for engine blocking (10A) and hood lock control (12A) Input for engine temperature sensor (included in delivery set) Input for hood trigger switch Ignition input Stand-alone mode Waterproof shockproof casing</p>

 A black, cylindrical wireless relay module with a multi-colored cable (red, blue, green, yellow, black) extending from one end. The module has a textured surface and a small rectangular cutout.	<p>R6 Eco wireless relay module</p> <p>Wireless service module for engine blocking and custom functionality Radio operation range – 2.4 GHz Bluetooth Low Energy Input power 5...12V, can be powered from engine sensors circuit Built-in accelerometer Built-in relays for engine blocking (0.5A) and other custom functionality Programmable outputs Stand-alone mode Waterproof shrink tube casing</p>
 A black, rectangular mini relay module with a multi-colored cable (red, blue, green, yellow, black) extending from one end. The module has a small black component on top and the text "StarLine" printed on its side.	<p>Start 6 mini relay module</p> <p>Relay module for remote engine start power circuits activation Built-in relays for IGN1, IGN2, ACC, Starter 2 relays with full contact groups for starter protection, engine blocking and other custom functionality</p>
 Two views of a BP-06 immobilizer bypass module. On the left is a closed, black, rectangular module. On the right is the same module with its top cover removed, revealing internal components including a battery, a microcontroller, and various electronic components.	<p>BP-06 immobilizer bypass module</p> <p>Digital module to perform remote start with factory immobilizer bypass with use of factory key or transponder inside Analogue and data bus control Built-in 3.3V power supply for Smart Keys</p>

Memo

Security system parts layout

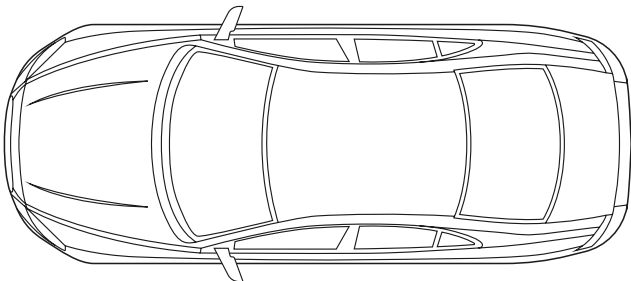

1

main unit

2

service button

3

start module

4

blocked circuit

5

siren

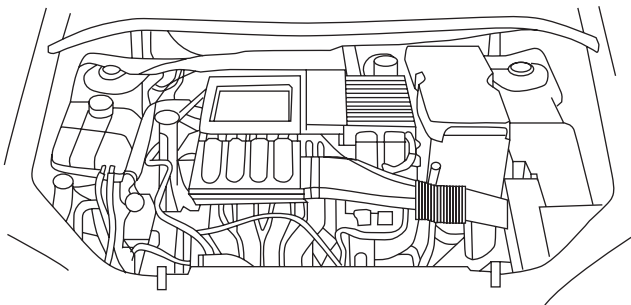

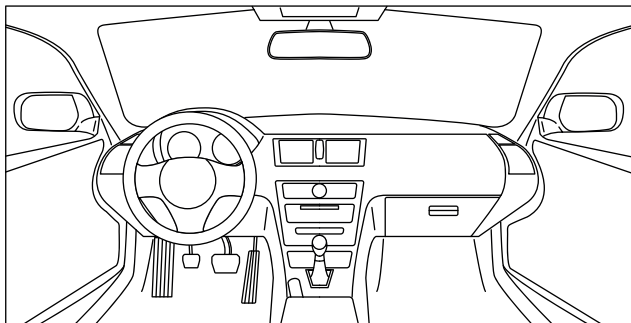

Personal info

Service code:

Emergency disarm code:

Pin-to-Drive buttons code sequence:

StarLine account Login / Password:

Approvals

StarLine E9 v2 vehicle security system conforms the relevant international regulations

Electromagnetic compatibility directive 2014/30 EU

UNECE vehicles and parts regulations R116 (VSS) and R10 (EMC)



The manufacturer reserves the right to modify and improve the product design and technical features without prior notice.

Manufacturer
ScPA StarLine Ltd
www.alarmstarline.com

Warranty terms

Warranty repair and replace is carried out by StarLine authorized dealers and service centers.

Warranty period is 3 years beginning from the date of purchase.

Service life is 5 years providing device is installed, configured and used according to the present instruction manual and connection diagram recommendations.

Warranty period for the optional accessories, i.e. relay modules, sirens, wireless sensors, immobilizer bypass modules, temperature sensors is 1 years from the date of purchase.

Warranty does not apply to batteries and installation accessories attached in deliver set.

Warranty is valid providing following conditions met:

- system is installed by qualified approved installer
- present instruction requirements, especially safety precautions are strictly followed
- attached warranty certificate is properly filled up

Free of charge warranty repair or replace is void in case of:

- warranty period is expired
- mechanical damage of security system main unit housing, circuit board, wire harness and other parts and accessories
- traces of unauthorized dismantling and repair attempts visible
- damages caused by a non-qualified installation
- other damages caused by external factors, i.e. fire, exceeding operating temperature range, water and aggressive fluids ingress, careless treatment etc.

Maintenance and repair of security system with expired or void warranty is carried out by any of approved or non-authorized service centers on a customer expense.

Purchase certificate

Model _____

Serial number _____

Date of purchase " ____ " _____ 20 ____

Reseller name, address, stamp and signature

Installation certificate

I, the undersigned _____
name, position

professional installer herein certify that above specified security system is properly installed and configured by me in full accordance with the manual, connection diagram and other related officially published recommendations of the manufacturer.

Car specification

Make _____ Model _____

VIN number _____

Installer name, address, stamp and signature

Customer name and signature

Date of installation " ____ " _____ 20 ____