

CM-2305 Wiring Schematic

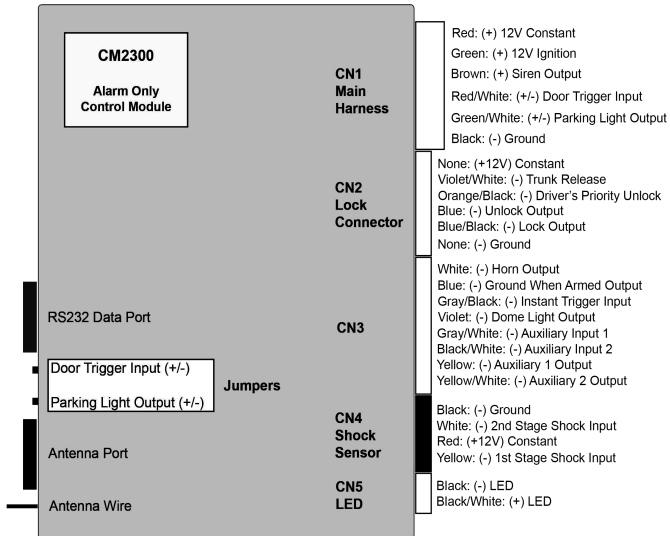

Antenna Port

Black: (-)
Red: (+12V)
White: (TX)
Yellow: (RX)

RS232 Data Port (Grey)

This port can be used for iDatalink modules or DroneMobile hardware.

Starter Kill Relay

The starter kill relay for the CM2300 is prewired to the Ignition (Green CN1) and Ground When Armed (Blue CN3) wires.

The Yellow and Yellow/Black wires go to and interrupt the vehicle's starter wire.

Make sure to connect the Green wire to the vehicle's ignition.