



Installation Manual

By Firstech LLC, Version: 1.0

Applicable to the following control modules:

- CM4200-DX (remote start)
- CM5200 (DT remote start with Blade)

- CM4000 (alarm and remote start)
- CM5000 (DT alarm and remote start with Blade)

- CM4300 (alarm)

This device complies with Part 15 of the FCC rules. Operation is subject to the following conditions;

(1) This device may not cause harmful interference.

(2) This device may accept any interference received, including interference that may cause undesired operation.

CAUTION: Changes or modifications not expressly approved by the party responsible for compliance could void the user's authority to operate this device.

Table of Contents

Introduction	3
Kit Contents	3
Installation Basics	4
Remote Programming Routine	5
Placement and Use of Components	6
Antenna and Cable	6
RPS-II (Remote Paging Sensor)	6
Secure Valet Switch.....	6
Firstech Shock Sensor	6
Siren.....	7
Thermistor (Temperature Sensor).....	7
Hood Pin	7
Backup Battery.....	7
Common Procedures	7
Jumper Settings	7
Tach Sensing	8
Alternator Sensing.....	8
No tach Sensing – (Automatic Transmission Vehicles Only)	8
Timed Crank Setting – CM4 Series or CM5 Series (Automatic Transmission Only)	9
Green/White Loop	9
Reservation Mode for Manual Transmissions	9
Version Diagnostics	10
CM5200 Wiring Schematic (Remote Start)	12
CM4200-DX Wiring Schematic (Remote Start)	13
CM5000 Wiring Schematic (Alarm and Remote Start)	14
CM4000 Wiring Schematic (Alarm and Remote Start)	15
CM5200, CM4200-DX, CM5000 and CM4000 Wiring Description	16
CM4300 Wiring Schematic (Alarm)	22
CM4300 Wiring Description	23
Option Programming Tables	25
Option Menu Descriptions	28
Special Option Groups 1 & 2	31
Option Programming	31
Troubleshooting	33
Technical Support Contacts	36

Introduction

Thank you for purchasing this Firstech system for your vehicle. The following installation manual is intended for experienced and authorized Firstech technicians. We highly recommend that you contact your local Firstech dealer and seek professional installation. Call 888-820-3690 or visit our websites at www.compustar.com or www.firstechllc.com to locate your nearest dealer.

This installation manual is for both CM4 Series and CM5 Series control modules. This manual supports CM4 series – version 37 or greater firmware and CM5 series – version 4 or greater firmware.

Some functions and features are not described in this install manual. Please see the remote's user manual(s) for detailed descriptions on those features.



Caution: The Manufacture's warranty will be void if this product is installed by anyone other than an authorized Firstech dealer. Firstech reserves installation support services to authorized dealers only.

Kit Contents

All Firstech CM4200-DX and CM5200 control modules include the following:

- CM4200-DX or CM5200 main control module
- Main ignition wiring harness with two relays
- Wiring harnesses
- Hood pin
- Thermistor temperature sensor (2 Way remote LCD systems only)

The following sensor is available but not included with every system:

- Firstech secure valet switch (Optional)

All Firstech CM4000, CM5000, and CM4300 control modules include the following:

- CM4000, CM5000, or CM4300 main control module
- Main ignition wiring harness with two relays. CM4300 modules include one relay.
- Wiring harnesses
- Hood pin
- Mountable bright blue LED
- Thermistor temperature sensor (2 Way remote LCD systems only)
- Firstech dual stage shock sensor

The following two sensors are available but not included with every system:

- Remote pager sensor (RPS-II) (Optional on 2 Way remote LCD systems only)
- Firstech secure valet switch (Optional)

The remote(s) and antenna are modular and are not specific to the control modules. You have the ability to pair almost any Firstech remote(s) and antenna receiver to the CM4 and CM5 Series.

Installation Basics

If you are new to installing Firstech Series Remote Starts and / or Alarms, we highly recommended that you thoroughly review this manual to installing your first unit.

Key Points to Consider Before Installation:

- You must code remotes to this system before anything will function***
Program remotes by cycling the ignition ON / OFF five times within seven seconds and tap button 1 (0.5 seconds) on the first remote, and then tap button 1 (0.5 seconds) on the second remote.
- RPS-II (Remote Paging Sensor)***
All 2 Way units include an optional RPS that has three main functions; **1.** Status LED, **2.** Remote notification when triggered, and **3.** Auto unlock/alarm disarm when a user specific 4 digit *knock* code is entered via tapping sensor through the windshield.
- New Secure Valet***
All units include an optional secure valet switch. This switch breaks the internal ignition connection to prevent the system from being put into valet when cycling the ignition ON / OFF five times.
- Internal green loop must be cut for AUTOMATIC transmission vehicles***
By default, CM4 and CM5 series units come in MANUAL transmission mode. You will need to cut the green loop inside the control module if you are installing the unit in a AUTOMATIC transmission.
- Different tach learning procedure***
Learn tach by: **1.** Starting the vehicle with the key, **2.** Pressing and holding the foot brake, and **3.** Holding the remote start button on the remote for 2.5 seconds - one chirp and parking light flash indicates that the vehicle tach signal has been successfully learned. Three chirps indicate that the CM4 or CM5 control module failed to see a proper tachometer signal. (*These units have the option for No Tach / Tachless and 1.5 second assume cranking*).
- New Option Menus***
The option menu is larger than the previous CM3 series control modules. It is important to familiarize yourself with the new options as it will save time in most applications. For instance, *Option 1-04* controls the double pulse unlock feature on all CM4 and CM5 series control modules.
- Option Programmer (OP500)***
Most options on these units can be programmed with the remote(s), however setting auxiliaries and Special Option Groups 1 and 2 require the use of the OP500. Please note, the system must be unlocked / disarmed to sync the OP500 with the control module. Otherwise, an "ER 01" message will show on the display of your OP500.
- Programmable Output Connectors (POC)*** Review wiring diagrams & programming sections
All control modules come with 9 programmable outputs that can be configured 19 different ways. It is important to familiarize yourself with the POCs as it will save time in most applications.
- Internet updatable processors*** Visit "Dealer Support" at www.compustar.com
All CM4 and CM5 series units are equipped with some of the most powerful processors available today. This flexibility allows for on-demand internet updating capabilities in the event of a version update or change.

Remote Programming Routine

IMPORTANT: Any and all remotes must be coded to the control module prior to performing any and all operations.

Remotes excluding P2WSSR

STEP 1: Activate programming mode by manually turning the vehicle's key between the Ign On and Off (or the Acc & On positions) five times within 7 seconds. The vehicle's parking lights will flash once with the successful completion of this step. (**Note:** *this step also places the control module into Valet Mode*)

STEP 2: Within a 2 second period after the 5th ignition cycle tap **Button I on two way remotes** or the **Lock button on one-way remotes** for 0.5 seconds. The parking lights will flash once to confirm the transmitter has been coded. Repeat for additional remotes, up to three.

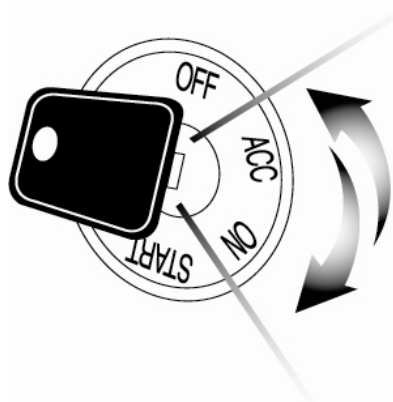

Exiting Programming: Programming is a timed sequence. After 2 seconds the parking lights will flash twice signaling the end of programming mode.

Programming Multiple Remotes: After the confirmation flash given in **STEP 2**, code additional remotes by tapping **Button I on two way remotes** or the **Lock button on one way remotes**. The parking lights will flash once confirming each additional remote. All systems (except the P2WSSR), can recognize up to three remotes.

Note: If you program only 1 Way remotes to a 2 Way antenna you will receive 3 parking light flashes and/or siren chirps when you turn the ignition on. This will be alleviated by programming a 2 Way remote.

Pro P2WSSR

STEP 1: Remove the AA battery from the remote.

STEP 2: Activate programming mode by manually turning the vehicle's key between the Ign On and Off (or the Acc & On positions) five times within 7 seconds. The vehicle's parking lights will flash once with the successful completion of this step. (**Note:** *this step also places the control module into Valet Mode*)

STEP 3: Within a 2 second period after the 5th ignition cycle, insert the AA battery into the remote. The parking lights will flash once to confirm this step. If you have an additional 1 Way remote tap the Lock button after inserting the AA battery into the 2 Way remote.

STEP 4: Wait several seconds for the parking lights to flash twice and the remote LCD to receive a page back. The transmitter has now been coded.

Programming Multiple Remotes: After the confirmation flash given in step 3, program the optional **1 Way remote** by tapping the Lock button for 0.5 seconds. The parking lights will flash once confirming that the 1 Way this remote has been learned. The P2WSSR can recognize (1) **2 Way remote** and (1) **1 Way remote**.

Placement and Use of Components

IMPORTANT: The placement and use of components are critical to the performance of this system.

Antenna and Cable

Firstech antennas are calibrated for horizontal installation at the top of the windshield. The cable that connects the antenna to the control module must be free from any pinches or kinks. Installing the antenna in areas other than the windshield may adversely affect the effective transmitting distance of the remotes.

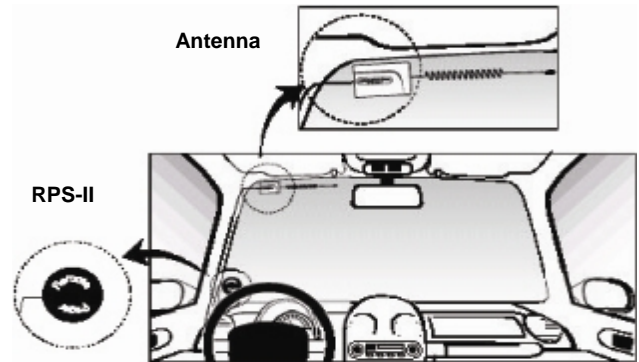

RPS-II (Remote Paging Sensor)

(CM4000, CM5000, and CM4300 Only) The RPS-II sensor is designed to be mounted on the inside of the windshield. Basic RPS functions do not require programming. There is a three position switch on the rear of the RPS-II. This adjusts the sensitivity of the RPS-II. The larger the circle the more sensitive the knock is. To activate the RPS unlock / disarm feature you must perform the following procedures:

STEP 1: Disarm/unlock the alarm. (Remotes must be programmed first.)

STEP 2: Turn ignition key to the "on" position and leave the driver's door open.

STEP 3: Knock on the windshield in front of the RPS a total of 10 times (**each time you knock the LED on the RPS will flash RED**). The LED will begin to flash rapidly in BLUE with successful completion of this step.

STEP 4: Enter the first digit of the desired four-digit pass code by knocking on the windshield in front of the RPS the desired number of times. For example, to enter 3, knock on the sensor 3 times (each time you knock the LED will flash RED) then wait.

STEP 5: The LED on the RPS will confirm your first number by flashing BLUE slowly. Once the LED begins to flash rapidly in BLUE, enter your second number by repeating step 4.

STEP 6: Repeat steps 4 & 5 to enter all four numbers.

STEP 7: Turn the ignition OFF. The RPS disarm/unlock feature is now programmed. Repeat steps 3 – 5 to enter your disarm/unlock code.

****The first two digits of the RPS unlock/disarm pass code will be the default pass code for the Secure Valet (you do not need to program them independently).**

Secure Valet Switch

The optional Secure Valet Switch prevents the alarm from being put into valet mode through cycling the ignition on/off five times. The Secure Valet Switch is more secure than traditional toggle / valet switches because it requires a two digit code. To program this feature you must perform the following procedures:

STEP 1: Turn on *Option 3-10-III*.

STEP 2: Turn ignition key to the "on" position.

STEP 3: Hold down the valet switch for 1.5 seconds. The LED on the valet switch will begin to flash rapidly with successful completion of this step.

STEP 4: Enter the first digit of the desired two-digit pass code by depressing the switch the number of times that coordinates with the desired first number. For example, to enter 3, depress the switch 3 times, then wait.

STEP 5: The LED will confirm the first number by flashing BLUE slowly. Once the LED begins to flash rapidly, enter your second number by repeating step 4.

STEP 6: Turn the ignition off - the Secure Valet Switch is now programmed. Follow steps 3 – 5 to enter your Secure Valet code.

****The first two digits of the RPS unlock/disarm pass code will be the default pass code for the Secure Valet (you do not need to program them independently).**

Firstech Shock Sensor

(CM4000, CM5000, and CM4300 Only) For best results mount the shock sensor by zip tying it to the vehicle's main ignition harness. There is a small dial on the sensor that ranges from Off to 10. The higher the number on the dial the greater sensitivity of impact. A small adjustment to the dial can make a

significant difference in sensitivity for both 1st and 2nd stages. Recommended dial settings for most vehicles is somewhere between 2 & 4.

Siren

(CM4000, CM5000, and CM4300 Only) The volume output of the siren can be increased 3 dB by cutting black wire loop located near the base of the siren. To adjust duration time when the alarm has been triggered, change *Option 3-07* – the system default is 30 seconds.

Thermistor (Temperature Sensor)

Every 2 Way remote - Firstech system includes an optional thermistor, which must be plugged into the 2 pin port of the control module for use. This plug is white on the CM4000 and blue on the CM5000. The use of the thermistor allows the 2 Way remote to display the vehicle's interior temperature on the remote LCD (liquid crystal display) as well as permitting the vehicle to start with timed *Hot or Cold starting*; see *options 2-05, 2-07 and 2-08*. **IMPORTANT:** New thermistor plugs are blue 2 pin connectors on the CM5 series but old white plug thermistors will still work.

Hood Pin

The hood pin switch triggers the alarm in the event the hood is opened while the alarm is armed. The hood pin also doubles as an important safety feature that prevents the remote start from engaging while the hood is open.

Backup Battery

(CM4000, CM5000, and CM4300 Only) The backup battery input on the control module / brain is for any optional battery backup unit (sold separately). The red positive lead (+) acts both as an input and charging output for a 12 Volt battery backup. A backup battery maintains basic alarm functionality when main vehicle power is lost. See the "Wiring Schematics" section(s) for complete details.

Common Procedures



Jumper Settings

Caution: Jumper settings affect the polarity and use of certain outputs. If these jumpers are used incorrectly, damage to the vehicle and /or control module may occur.

Jumper 1 (Door Trigger Polarity)

Determines the polarity of the door trigger input wire (red/white). In the default position the door trigger registers negative (-) triggers. To change to a positive (+) trigger, move the jumper.

Jumper 2 (Glow Plug or Key Sense Polarity)

Determines the polarity of the glow plug or key sense input wire (brown/white). In the default position it monitors a positive (+) glow plug input. To change to a negative (-) input move the jumper. To change from the glow plug to the key sense setting, you must change *Option 4-09*.

Jumper 3 (Parking Light to Trunk Output)

Determines the output type (not polarity) of the green/white wire on connector one (CN1). In the default position it provides a positive (+) parking light output. To change to a positive (+) trunk output move the jumper. A negative (-) parking light output is found on connector three (CN3) and a negative (-) trunk output is found on connector four (CN4).

Setting Auxiliary Outputs on Connector 3

You Must Have the OP500 Option Programmer

To set auxiliary outputs on the control module involves the new Programmable Output Connector wires (POCs). You must choose two odd pin wires on the black 18 pin connector that you are not using. For example we will use POC 8 and 9.

STEP 1: Plug in OP500 and use the Right or Left Arrow Button to scroll through the menu to POC 8 and POC 9 on LCD Line 1.

STEP 2: Use the Up or Down Arrow Button to change the lower number on LCD Line 2 to 10 – Auxiliary 1 or 11- Auxiliary 2.

STEP 3: Scroll up the menu to Option 4-01 and 4-02 and set the options. Please see the Option Table for details.

STEP 4: The Pro control modules have a secure auxiliary option 4-05. This requires you to tap button 4 before you tap button 2 for Aux 1 or button 3 for Aux 2. On 1-Way remotes you must hold the Trunk and Key/Start buttons for 2.5 seconds then tap the Trunk button for Aux 1 or the Key/Start button for Aux 2.

STEP 5: If you need to change the time settings of the outputs go to AU1 or AU2 on the OP500. LCD Line 2 is the timed output.

STEP 6: Hold the “W” Write button for 3 seconds to set all the options.

Tach Sensing

The default engine sensing mode is tach. In cold weather climates we recommend using an injector wire verses a coil wire for tachometer sense. There are new features that adjust tach reading methods on option 2-01. **IMPORTANT:** The remotes must be coded prior to setting up tach sensing. Firstech recommends using a digital multimeter to test for tach.

STEP 1: Start the vehicle with the key. Allow time for the engine to idle down.

STEP 2: Test wire and make connection. At idle the tach wire should test between 1 to 4 Volts AC. As the vehicle RPM's increase the voltage on the meter will also increase. Always solder tach connections.

STEP 3: Learn tach. While the vehicle is at idle, hold the foot brake and press and hold the remote start button on the remote control for 2.5 seconds.

The parking lights will flash once and the siren will chirp once to confirm a good tach signal. The parking lights will flash three times and the siren will chirp three times to indicate the tach did not learn. Two seconds following the three flashes, the number of parking light flashes will indicate the cause of the error:

Number of Parking Light Flashes	Tach Error
1	Option 2-10 is not in default setting 1
2	Key is in the off position
3	Bad tach signal. Find a different wire.

Alternator Sensing

Alternator sensing is an alternative method the remote start can utilize to determine if the engine is running. This is different than the no tach sensing mode so a connection must be made. **IMPORTANT:** The remotes must be coded prior to setting up alternator sensing.

STEP 1: Change *Option 2-10 to setting 2* - Alternator sensing.

STEP 2: Test wire and make connection. The stator wire is found at the vehicle's alternator. Change your multimeter to DC voltage before testing for this wire.

A. At rest, with the ignition off, the stator wire should test 0V DC.

B. Turn the ignition to the run position. The stator wire should now test between 4 – 6V DC.

C. Start the vehicle with the key. The stator wire should now test between 12 – 14V DC at idle.

STEP 3: Process complete – no further programming is required.

No Tach Sensing – (Automatic Transmission Vehicles Only)

No tach sensing is an alternative engine sensing mode. No tach sensing does not require a connection to the vehicle other than the main ignition harness.

STEP 1: Change *Option 2-10* to *setting 3* - No tach sensing.

STEP 2: Process complete – there is no further programming required other than adjusting crank time when necessary (see below).

Adjusting Crank Time: To adjust minimum crank times, refer to *Option 2-12*. To help ensure successful starting, the system will automatically add additional crank time to the 2nd and 3rd start attempts. In addition, there is a built in “Smart Resting Mode”. Traditional tach sensing is still highly recommended for colder climates.

Timed Crank Setting – CM4 Series V.37 or CM5 Series (Automatic Transmission Only)

Option 2-10 setting 4 provides a timed 1.5 second crank for the remote start sequence. This option just cranks the vehicle for 1.5 seconds and assumes remote start has completed. This option can be used for GM and other vehicles with built in anti-grind systems.

Green/White Loop

This loop wire determines the transmission setting. The default position (uncut loop) is for manual transmissions. When the loop is cut, the system will be ready for automatic transmissions. In the default (manual transmission) mode, the system must be set up in Reservation mode prior to the vehicle being able to remote start. **IMPORTANT:** All warranties or claims are void if a controller with a cut loop is installed on a vehicle with a manual transmission.

Reservation Mode for Manual Transmissions

To remote start a manual transmission vehicle, the system must first be set up in reservation mode. Reservation mode is designed to prevent the vehicle from remote starting while the transmission is in gear.

Installation Requirements

1. The vehicle's door triggers must be connected to the control module. Prior to making final connections, test the factory door triggers to ensure that they are functioning properly.
2. The vehicle's emergency/parking brake wire must be connected to the control module. The proper vehicle wire usually provides a negative (-) trigger while the emergency / parking brake is set.
3. The vehicle's clutch must be momentarily bypassed while the remote start cranks the engine. This momentary bypass simulates the clutch being depressed. For complete details on how to wire a momentary clutch bypass consult your CompuTech program or contact our technical support department by calling 888-820-3690.

IMPORTANT: Do not install a remote start in manual transmission vehicles with convertible / removable tops and in user's vehicles that leave their windows down. Firstech nor their authorized dealers will assume responsibility for improper use or install.

Activating Reservation Mode

STEP 1: Start the vehicle with the key. Place the transmission in neutral, remove pressure from the pedal brake, and set the emergency/parking brake.

STEP 2: Remove the key from the vehicle's ignition. The vehicles engine should remain running even after the key has been removed. If the vehicle does not remain running, check the emergency / parking brake connection.

STEP 3: Exit the vehicle and close the door. The vehicle's engine should shut off upon closing the door. If the vehicle's engine does not shut off, check the door trigger connection or wait for the factory dome-light to go out. The Firstech system is in reservation mode and the vehicle is ready to safely remote start.

Additional Notes

Reservation mode will be cancelled if the control module recognizes the vehicles door, hood or trunk opening – or if the alarm is triggered. Each time the end user wants to remote start their manual transmission vehicle, they must set the control module in reservation mode. Reservation mode settings can be programmed with *Option 1-06*.

Version Diagnostics

All the new control modules come with the ability to check which firmware is on the module. This is accomplished by turning the ignition on. Then with 2 Way remotes you must hold buttons 1 and 4 together for 2.5 seconds. With the 1 Way remotes you must hold the Lock and Key/Start buttons together for 2.5 seconds. Current versions of CM4 Series V.37 and CM5 Series V.4 will flash 5 times when attempting Version Diagnostics.

ADS Blade Cartridge Slot and Connector

This is the main feature of the new CM5000 and CM5200. The slot gives you the ability to use the Blade-AL and Blade-TB modules from Firstech and ADS. With these modules you can virtually eliminate all wire connections between your control module and bypass module. You only need to connect the main ignition harness and your needed wires on the 20 pin Blade connector. For more information on how to program and wire the Blade please visit www.idatalink.com/compustar for the specific wiring diagram for that vehicle.

Blade system includes:

1. Blade-AL or Blade-TB (**NOTE:** These modules are blank and must be flashed on your computer.)
2. 20 Pin wiring harness
3. 3 Pin harness used in some installs

IMPORTANT: Install diagrams are not included and must be downloaded from www.idatalink.com/compustar. When flashing the Blade you **can** use the Y-Cable OP500 end and **not** CM4 Series end. ADS and Firstech recommends using the 4 pin RS232 cable to avoid confusion. Cartridge must be removed to flash the control module firmware.

NOTE: The ADS-RNG C1, ADS-RNG C2, and ADS-RNG GM3 are not included and must be purchased separately. The 20 pin Blade connector comes only with the Blade cartridge and not the CM5 control modules.

WARNING: Manufacturer or seller will have no responsibility for any injuries and/or damages caused by improper care of the product such as decomposition, conversion, and transform done by a user voluntarily. **WARNING:** There should be no wiring routed around any pedals which can cause a driving hazard.

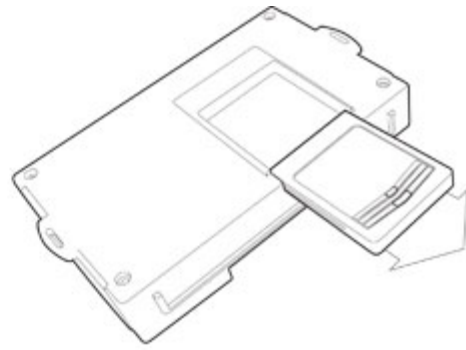
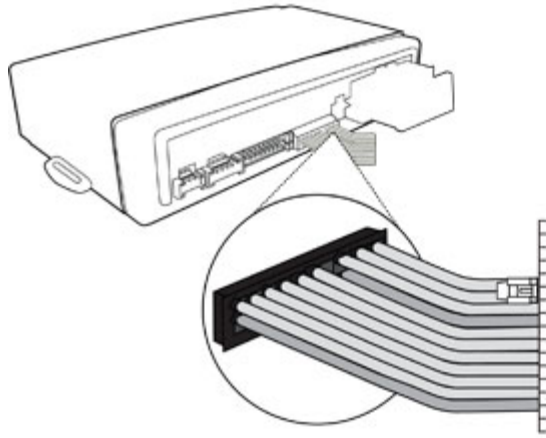

01	02	03	04	05	06	07	08	09	10
11	12	13	14	15	16	17	18	19	20

CM5200 Wiring Schematic (Remote Start)

The CM5200 is the control module for all remote start units. This controller is universal regardless of remote or antenna type.

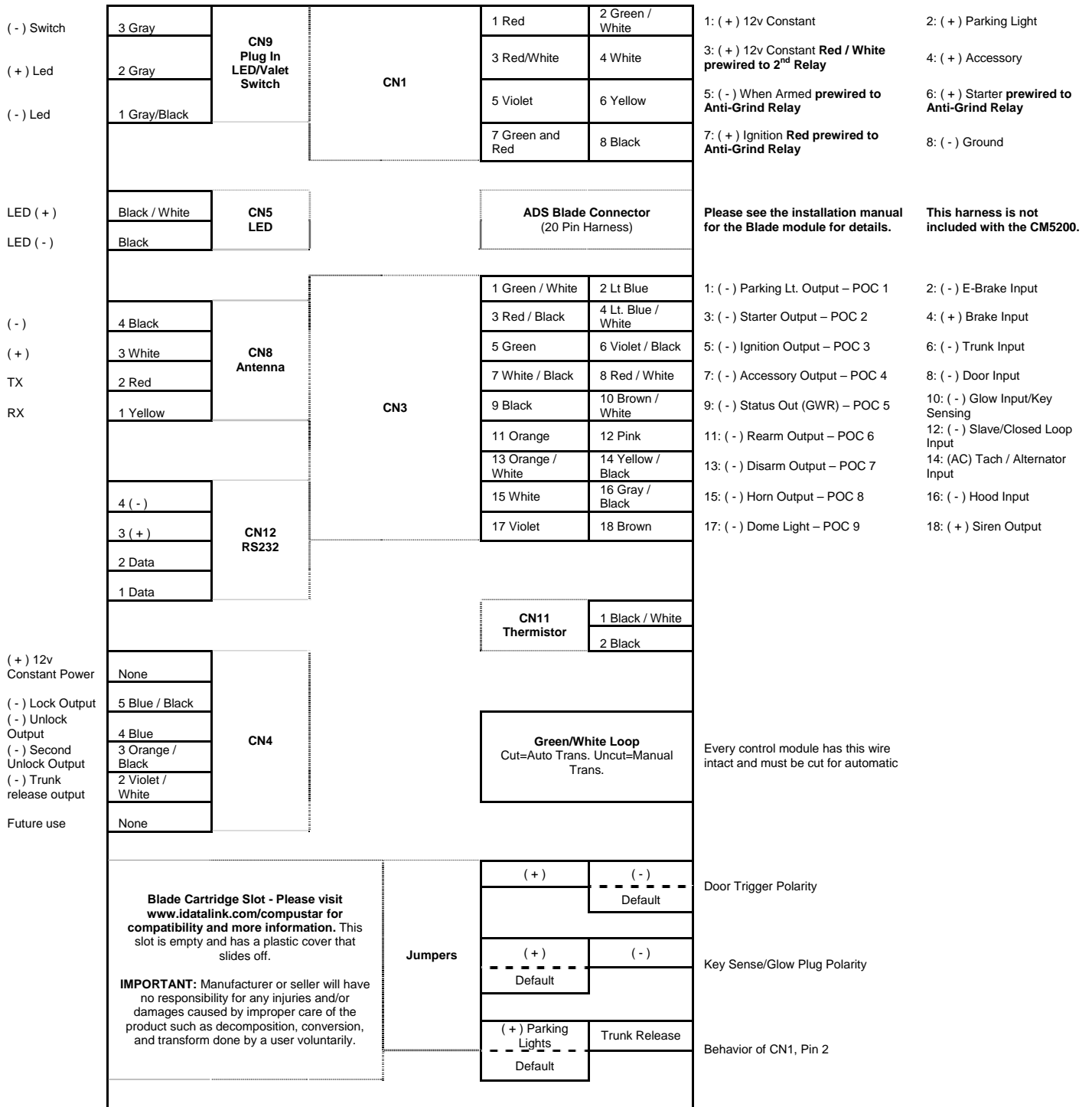

CM4200-DX Wiring Schematic (Remote Start)

The CM4200-DX is the control module for all remote start units. This controller is universal regardless of remote or antenna type.

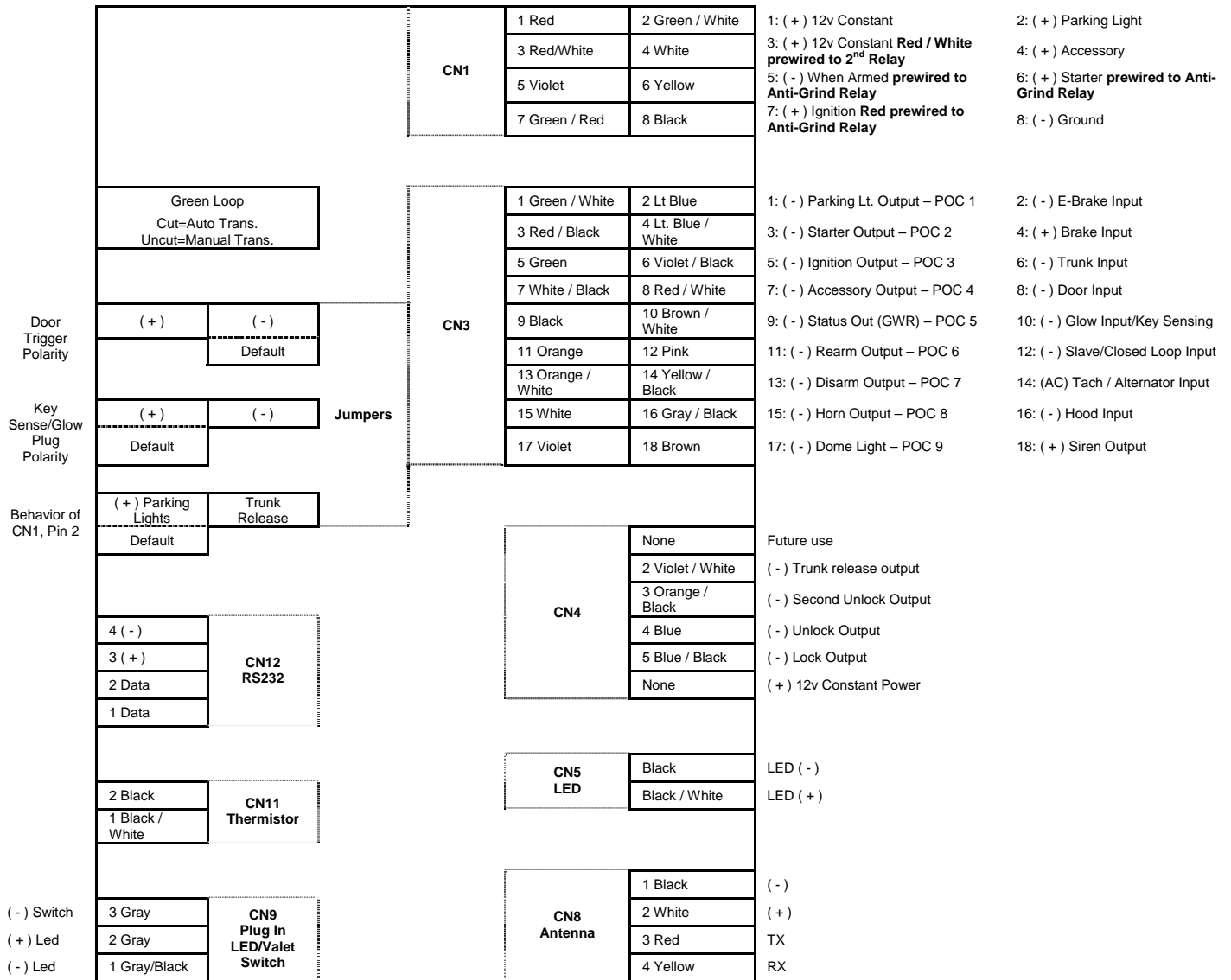

CM5000 Wiring Schematic (Alarm and Remote Start)

The CM5000 is the control module for all alarm and remote start combo units. This controller is universal regardless of remote or antenna type.

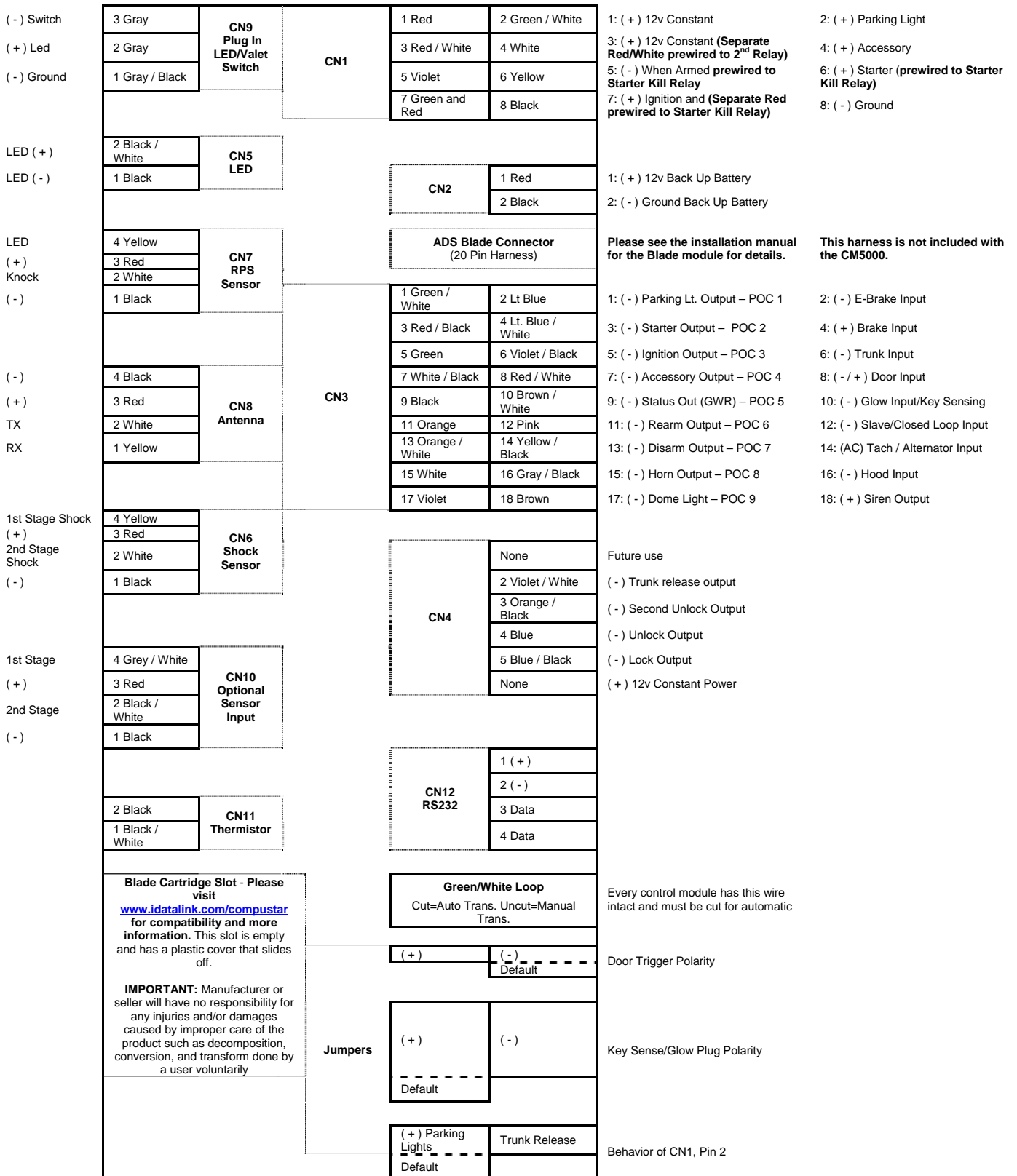

CM4000 Wiring Schematic (Alarm and Remote Start)

The CM4000 is the control module for all alarm and remote start combo units. This controller is universal regardless of remote or antenna type.

		CN1		1 Red	2 Green / White	1: (+) 12v Constant	2: (+) Parking Light
				3 Red / White	4 White	3: (+) 12v Constant and Red/White prewired to 2 nd Relay	4: (+) Accessory
				5 Violet	6 Yellow	5: (-) When Armed prewired to Starter Kill Relay	6: (+) Starter prewired to Starter Kill Relay
				7 Green and Red	8 Black	7: (+) Ignition and Red prewired to Starter Kill Relay	8: (-) Ground
		CN2		1 Red		1: (+) 12v Back Up Battery	
				2 Black		2: (-) Ground Back Up Battery	
		CN3		1 Green / White	2 Lt Blue	1: (-) Parking Lt. Output – POC 1	2: (-) E-Brake Input
				3 Red / Black	4 Lt. Blue / White	3: (-) Starter Output – POC 2	4: (+) Brake Input
				5 Green	6 Violet / Black	5: (-) Ignition Output – POC 3	6: (-) Trunk Input
				7 White / Black	8 Red / White	7: (-) Accessory Output – POC 4	8: (- / +) Door Input
				9 Black	10 Brown / White	9: (-) Status Out (GWR) – POC 5	10: (-) Glow Input/Key Sensing
				11 Orange	12 Pink	11: (-) Rearm Output – POC 6	12: (-) Slave/Closed Loop Input
				13 Orange / White	14 Yellow / Black	13: (-) Disarm Output – POC 7	14: (AC) Tach / Alternator Input
				15 White	16 Gray / Black	15: (-) Horn Output – POC 8	16: (-) Hood Input
				17 Violet	18 Brown	17: (-) Dome Light – POC 9	18: (+) Siren Output
		CN4		None		Future use	
				2 Violet / White		(-) Trunk release output	
				3 Orange / Black		(-) Second Unlock Output	
				4 Blue		(-) Unlock Output	
				5 Blue / Black		(-) Lock Output	
				None		(+) 12v Constant Power	
		CN5 LED		Black		LED (-)	
				Black / White		LED (+)	
		CN6 Shock Sensor		1 Black		(-)	
				2 White		2nd Stage Shock	
				3 Red		(+)	
				4 Yellow		1st Stage Shock	
		CN7 RPS Sensor		1 Black		(-)	
				2 White		Knock	
				3 Red		(+)	
				4 Yellow		LED	
		CN8 Antenna		1 Black		(-)	
				2 White		(+)	
				3 Red		TX	
				4 Yellow		RX	
Green Loop Cut=Auto Trans. Uncut=Manual Trans.							
Door Trigger Polarity	(+)	(-)	Jumpers				
	Default						
Key Sense/Glow Plug Polarity	(+)	(-)					
	Default						
Behavior of CN1, Pin 2	(+) Parking Lights	Trunk Release					
	Default						
		CN12 RS232					
				4 (-)			
				3 (+)			
				2 Data			
				1 Data			
		CN11 Thermistor					
				2 Black			
				1 Black / White			
1st Stage		CN10 Optional Sensor Input					
				4 Grey / White			
(+)				3 Red			
2nd Stage				2 Black / White			
(-)				1 Black			
(-) Switch		CN9 Plug In LED/Valet Switch					
				3 Gray			
(+) Led				2 Gray			
(-) Led				1 Gray / Black			

CM5200, CM4200-DX, CM5000 and CM4000 Wiring Description

Connector 1 (CN1), 8-Pin

7	5	3	1
8	6	4	2

- Pin 1 **Red** - Constant 12V positive (+) power input. This wire must be connected. The proper vehicle wire will test (+) 12V at all times - while the key is in the off position, the on position and during crank.
- Pin 2 **Green/White** – This is a dual-purpose wire that features selectable functionality thru the *trunk/light* jumper on the control module. It is either a positive (+) parking light output or positive (+) trunk output.

Default - Parking light positive (+) output. The proper vehicle wire will test (+) 12V when the parking light switch is in the on position.

Optional – Trunk release positive (+) output. The proper vehicle wire will test (+) 12V when the trunk release is triggered.

- Pin 3 **Red/White** - Constant 12V positive (+) power input. This wire must be connected. The proper vehicle wire will test (+) 12V at all times - while the key is in the off position, the on position and during crank.
- This pin also has a red/white wire that is pre-wired to a relay. The short violet wire on Pin 85 is the trigger input wire that determines the (+) 12V output type of the long blue wire on Pin 30. For example, connecting the negative (-) Ignition output from Connector 3, to the short violet wire coming off of the relay, will provide an additional (+) 12V Ignition output from the long blue wire.

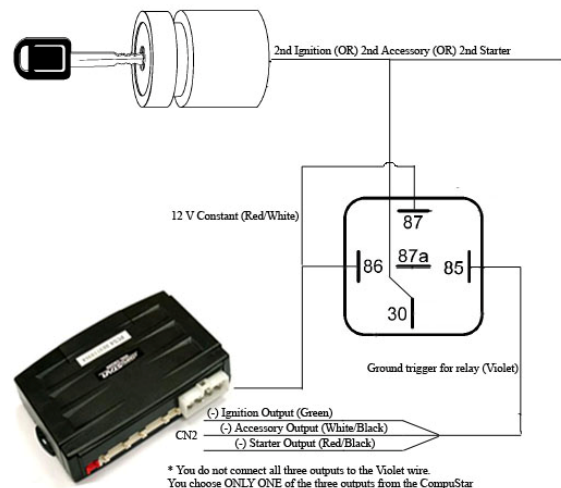

- Pin 4 **White** – Accessory 12V positive (+) output. This wire must be connected to the vehicle accessory / HVAC blower motor wire. The proper wire will test 0V with the key in the off position, (+) 12V while key is in the on position, 0V while cranking and back to (+) 12V when the key is returned to the on position.
- Pin 5 **Violet** - 250mA negative (-) output when armed and during remote start (while running). This wire is pre-wired to the anti-grind/starter-kill relay.
- Caution:** When this wire is being used to trigger aftermarket accessories it must be diode isolated.

- Pin 6 **Yellow** - Starter 12V positive (+) output. This wire is pre-wired to Pin 87a of the anti-grind/starter-kill relay. This wire must be connected for remote start. The proper wire will test 0V with the key in the off position, 0V while the key is in the on position and (+) 12V during crank.

There are two wires coming off of the relay; yellow-black and yellow. To utilize the anti-grind or starter-kill features, the vehicles starter wire must be cut in half, otherwise, cut the relay out of the harness and connect the yellow (Pin 6) directly to the vehicles' starter wire.

IMPORTANT: For anti-grind and starter-kill applications, the yellow wire goes to the starter side of the vehicles starter wire and the yellow/black goes to the key side.

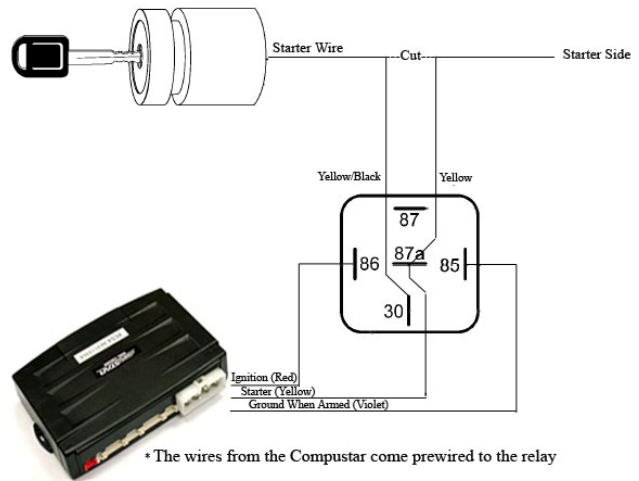

Pin 7 **Green** – Ignition 12V positive (+) output and input. This wire must be connected to the vehicles ignition for remote start and valet/programming. The proper wire will test 0V with the key in the off position, 12V (+) while the key is in the on position and 12V (+) during crank.

Red – Ignition 12V positive (+) output. This wire does not need to be connected. It is pre-wired to the anti-grind/starter-kill relay to supply it with power.

Pin 8 **Black** - Ground negative (-) input. This wire must be connected to the vehicles ground.

Connector 2 (CN2), 2-Pin: Optional Battery Back-up



Pin 1 **Red** - Constant 12 V positive (+) input and (+) charging output.

Pin 2 **Black** - Ground (-) negative input.

Connector 3 (CN3), 18-Pin: Programmable Output Connector (POC)

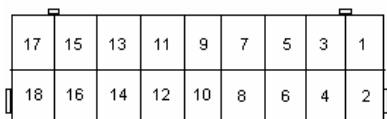

IMPORTANT: Odd Pin numbers 1 through 17 are programmable for up to 12 different output types. Refer to Special Option Group 2 for complete details (pages 32 & 36).

Pin 1 **Green/White IPOC 11** - Parking light 250mA negative (-) output. The proper wire will test (-) when the parking light switch is in the on position.

Pin 2 **Light Blue** – Parking / Emergency brake negative (-) input. This input is required for manual transmission/reservation and turbo-timer mode. The proper wire will provide a (-) trigger when parking / emergency brake is set.

- Pin 3 **Red/Black [POC 2]** – 2nd Starter 250mA negative (-) output. This output can be used to trigger the pre-wired relay located on the main ignition harness.
- Pin 4 **Light Blue/White** - Brake 12V positive (+) input. This input must be connected as it provides a shut down for the remote start. The proper wire will test (+) 12V while the foot brake is pressed.
- Pin 5 **Green [POC 3]** - 2nd Ignition 250mA negative (-) output. This output can be used to trigger the pre-wired relay located on the main ignition harness.
- Pin 6 **Violet/Black** - Trunk negative (-) input. This is an optional input that will monitor when the vehicle's trunk has been opened. The proper wire will provide a (-) trigger while the trunk is open.
- Pin 7 **White/Black [POC 4]** - 2nd Accessory 250mA negative (-) output. This output can be used to trigger the pre-wired relay located on the main ignition harness.
- Pin 8 **Red/White** - Door trigger input. This wire monitors negative (-) or positive (+) trigger door-pins. The proper wire will provide a (-) trigger or a (+) trigger only when the doors are opened. You will need to test the wire for proper polarity and set door dip switch on the control module for the corresponding polarity. **IMPORTANT: This wire is required for manual transmission remote starts.**
- Pin 9 **Black [POC 5]** – Status/Ground while running 250mA negative (-) output. This is an optional output that will provide a negative (-) output before the ignition cranks and stay on throughout the remote start duration. This wire is most commonly used to trigger bypass / transponder modules.
- Pin 10 **Brown/White** - This is a dual-purpose wire that is selectable through *Option 4-9* in the programming table. Select the polarity through the *glow/key* jumper on the control module. It can be set to accept either a positive (+) or negative (-) wait to start input / key sense.
- Default** – Glow plug positive (+) or negative (-) input. The proper vehicle wire will show a (+) or (-) trigger while the wait to start light is on. This wire will delay the starter output momentarily to allow the glow plugs to warm up on vehicles equipped with a diesel engine. You can adjust the delay with *Option 2-3*.
- Optional** – Key sense positive (+) or negative (-) input. The proper wire will show a (+) or (-) trigger only when the key is in the ignition. The purpose of the key sense is to prevent the system from passively arming or setting reservation mode while the key is still in the ignition.
- Pin 11 **Orange [POC 6]** - Factory Arm 250mA negative (-) output. This is an optional output that will provide a (-) pulse during lock, after crank and again after the ignition shuts down.
- Pin 12 **Pink** - Slave/Closed Loop negative (-) input. This is a dual-purpose optional input that can be changed through *Option 4-10*.
- Default:** Slave/Timer Start (-) input. This is most commonly used when adding a remote start to a factory keyless entry system. You can adjust the number of pulses with *Option 2-4*.
- Optional:** Closed Loop (-) input. This wire acts as an instant trigger when separated from ground (-). It is most commonly used to protect headlights or trailers.
- Pin 13 **Orange/White [POC 7]** - Factory Disarm 250mA negative (-) output. This is an optional output that will provide a (-) pulse during unlock and prior to the ignition turning on.

- Pin 14 **Yellow/Black** - Engine sensing input. This wire is connected to the vehicles Tach or Alternator wire and is required if you are not using the no tach sense setting. **IMPORTANT: To change engine-sensing modes, you must change Option 2-10; Default requires a Tach input.**
- Pin 15 **White [POC 8]** - Horn honk 250mA negative (-) output. This is an optional output that will pulse the factory horn. The proper wire will show ground (-) while the horn is sounding. To change horn output settings, review *Options 3-8 and 3-9*.
- Pin 16 **Gray/Black** – Hood Pin negative (-) input. This input is a safety shut down and alarm trigger. It prevents the vehicle from remote starting while the hood is open and triggers the alarm if the hood is opened while the alarm is armed. You can connect this wire to the hood pin supplied with this kit, or to a wire in the vehicle that shows (-) only while the hood is open.
- Pin 17 **Violet [POC 9]** - Dome light 250mA negative (-) output. This is an optional output that will provide a 30 second (-) negative output after system is unlocked for dome-light supervision. To change dome light output settings, review *Option 3-2*.
- Pin 18 **Brown** - Siren 12V positive (+) output. Connect this wire to the (+) wire located on the siren. To change siren output settings, review *Option 3-7*.

Connector 4 (CN4), 6-Pin

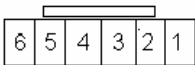

- Pin 1 **Not used**
- Pin 2 **Violet/White** - Trunk release 250mA negative (-) output. This is an optional output that will release the trunk. Use CN1, Pin 2 if the vehicle is equipped with a (+) trunk release. System will unlock doors and disarm alarm prior to trunk release.
- Pin 3 **Orange/Black** - 2nd Unlock 250mA negative (-) output. This is an optional output that will provide a (-) pulse for driver's priority door lock. **IMPORTANT: You must isolate the driver's door and turn on Option 1-3.**
- Pin 4 **Blue** - Unlock 250mA negative (-) output. This is an optional output that will provide a (-) pulse for unlocking doors. System will unlock doors and disarm alarm. **IMPORTANT: You must reverse polarity for (+) trigger door lock systems. For additional lock settings review Option Group 1 (page 31).**
- Pin 5 **Blue/Black** - Lock 250mA (-) negative output. This is an optional output that will provide a (-) pulse for locking doors. System will lock doors and arm alarm. **IMPORTANT: You must reverse polarity for (+) trigger door lock systems. For additional lock settings review Option Group 1 (page 31).**
- Pin 6 **Not used**

Connector 5 (CN5), 2-Pin (Pre-wired LED)



Note: Do not mistake for Thermistor port.

Pin 1 **Black** - L.E.D negative (-) ground.

Pin 2 **Black/White**- L.E.D. 3V positive (+) output.

Connector 6 (CN6), 4-Pin (Pre-wired Shock Sensor)

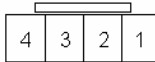

Pin 1 **Black** - Negative (-) ground.

Pin 2 **White** - 2nd stage negative (-) input. (Instant trigger)

Pin 3 **Red** - 12V positive (+) output.

Pin 4 **Yellow** - 1st stage negative (-) input. (Warn away)

Connector 7 (CN7), 4-Pin (Pre-wired RPS)

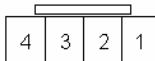

Pin 1 **Black** - Negative (-) ground.

Pin 2 **White** - Negative (-) paging input.

Pin 3 **Red** - 12V positive (+) output.

Pin 4 **Yellow** - 9V positive (+) L.E.D. output.

Connector 8 (CN8), 4-Pin (Pre-wired Antenna Cable)

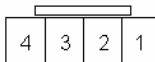

Pin 1 **Yellow** - RX input. This wire receives the signal from remote.

Pin 2 **White** - TX output. This wire transmits the signal to remote.

Pin 3 **Red** – Constant 12V positive (+) output.

Pin 4 **Black** – Negative (-) ground.

Connector 9 (CN9), 3-Pin (Pre-wired Valet/Programming Switch)

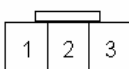

Pin 1 **Gray/Black** - Negative (-) ground.

Pin 2 **Gray** – 3V positive (+) L.E.D. output.

Pin 3 **Gray** – Negative (-) output.

Connector 10 (CN10), 4-Pin (Optional Sensor Input)

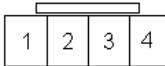

This connector provides optional sensor inputs. Most commonly used with proximity and tilt sensors.

Pin 1 **Black** – Negative (-) ground.

Pin 2 **Black/White** - 2nd stage negative (-) input. (Instant trigger)

Pin 3 **Red** – 12V positive (+) output.

Pin 4 **Grey/White** - 1st stage negative (-) input. (Warn away)

Connector 11 (CN11), 2-Pin (Pre-wired Thermistor)



Plug optional thermistor into this connector to monitor the vehicles' temperature. It used in conjunction with *Timer Start* features along with displaying temperature on two-way LCD's. To use *Timer Start* features review *Option Group 2* (page 31). **IMPORTANT:** New Thermistor plugs are blue 2 pin connectors on the CM5 series but old white plug Thermistors will still work.

Pin 1 **Black** - Thermistor

Pin 2 **Black/White** - Thermistor

Connector 12 (CN12), 4-Pin (RS 232 Data Port)

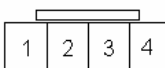

This connector is used for updating control modules via www.compustar.com. You must also use this port to flash ADS Blade bypass modules. This port provides simple connectivity of Fortin and iDataLink bypass modules.

CM4300 Wiring Description

Connector 1 (CN1), 4-Pin

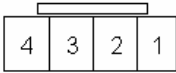

- Pin 1 **Red** - Constant 12V positive (+) power input. This wire must be connected. The proper vehicle wire will test (+) 12V at all times - while the key is in the off position, the on position and during crank.
- Pin 2 **Green/White** – This is a dual-purpose wire that features selectable functionality thru the *trunk/light* jumper on the control module. It is either a positive (+) parking light output or positive (+) trunk output.
- Default** - Parking light positive (+) output. The proper vehicle wire will test (+) 12V when the parking light switch is in the on position.
- Optional** – Trunk release positive (+) output. The proper vehicle wire will test (+) 12V when the trunk release is triggered.
- Pin 3 **Brown** - Siren 12V positive (+) output. Connect this wire to the (+) wire located on the siren. To change siren output settings, review *Option 3-7*.
- Pin 4 **Black** - Ground negative (-) input. This wire must be connected to the vehicles ground.

Connector 2 (CN2), 2-Pin: Optional Battery Back-up



- Pin 1 **Red** - Constant 12 V positive (+) input and charging output for a back-up battery.
- Pin 2 **Black** - Ground (-) negative input for back-up battery.

Connector 3 (CN3), 18-Pin: Programmable Output Connector (POC)

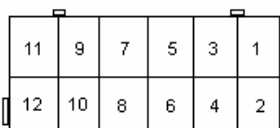

IMPORTANT: Odd Pin numbers 1 through 11 are programmable for up to 12 different output types. Refer to Special Option Group 2 for complete details (pages 32 & 36).

- Pin 1 **Green/White [POC 1]** - Parking light 250mA negative (-) output. The proper wire will test (-) when the parking light switch is in the on position.
- Pin 2 **Violet/Black** - Trunk negative (-) input. This is an optional input that will monitor when the vehicle's trunk has been opened. The proper wire will provide a (-) trigger while the trunk is open.
- Pin 3 **Orange [POC 6]** - Factory Arm 250mA negative (-) output. This is an optional output that will provide a (-) pulse during lock.
- Pin 4 **Red/White** - Door trigger input. This wire monitors negative (-) or positive (+) door-pins. The proper wire will provide a (-) trigger or a (+) trigger only when the doors are opened. You will need to test the wire for proper polarity and set the door dip switch on the control module for the corresponding polarity.
- Pin 5 **Orange/White [POC 7]** - Factory Disarm 250mA negative (-) output. This is an optional output that will provide a (-) pulse during unlock.
- Pin 6 **Brown/White** – Key sense positive (+) or negative (-) input. The proper wire will show a (+) or (-) trigger only when the key is in the ignition. Select the polarity through the *Key Sense* jumper on the control module. The purpose of the key sense is to prevent the system from passively arming while the key is in the ignition.
- Pin 7 **White [POC 8]** - Horn honk 250mA negative (-) output. This is an optional output that will pulse the factory horn. The proper wire will show ground (-) while the horn is sounding. To change horn output settings, review *Option 3-9*.
- Pin 8 **Gray/Black** – Hood Pin negative (-) input. This input is for alarm trigger. It triggers the alarm if the hood is opened while the alarm is armed. You can connect this wire to the hood pin supplied with this kit, or to a wire in the vehicle that shows (-) only while the hood is open.
- Pin 9 **Violet [POC 9]** - Dome light 250mA negative (-) output. This is an optional output that will provide a 30 second (-) negative output after the system is unlocked for dome-light supervision. To change dome light output settings, review *Option 3-2*.
- Pin 10 **Green** – Ignition 12V positive (+) output and input. This wire must be connected to the vehicles ignition for valet/programming. The proper wire will test 0V with the key in the off position, 12 V (+) while the key is in the on position and 12V (+) during crank.

The green ignition wire goes to Pin 86 on a pre-wired relay used for starter-kill. To utilize the starter-kill features, the vehicles starter wire must be cut in half. The proper wire will test 0V with the key in the off position, 0V while the key is in the on position and (+) 12V during crank.

IMPORTANT: For anti-grind and starter-kill applications, the yellow wire goes to the starter side of the vehicles starter wire and the yellow/black goes to the key side.

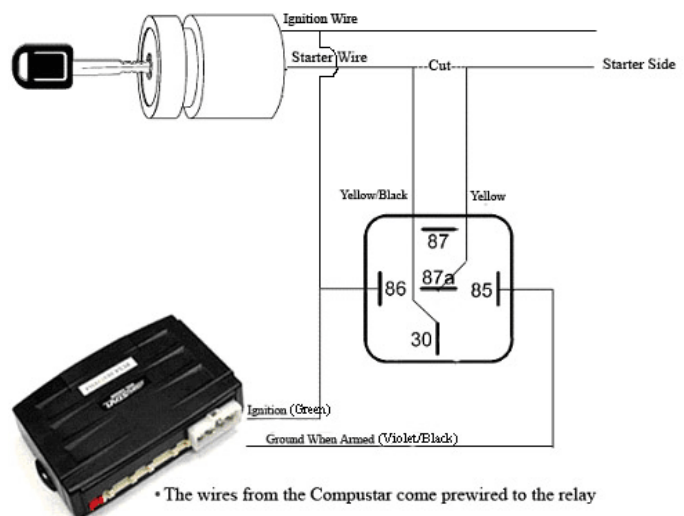

Pin 11 **Violet/Black** - 250mA negative (-) output when armed. This wire is pre-wired to the starter-kill relay.



Caution: When this wire is being used to trigger aftermarket accessories it must be diode isolated.

Pin 12 **Not used**

The rest of the connectors on the CM4300 are the same as the CM5000 and CM4000. Please see the CM5200, CM4200-DX, CM5000 and CM4000 Wiring Description for those details.

OPTION GROUP 1					
	Feature	Default Setting - I	Optional Setting - II	Optional Setting - III	Optional Setting - IV
1-01	Unlock before, Lock after, starting	Off	On	Lock After Remote Start Only	Lock After Shutdown Only
1-02	Lock / Unlock pulse duration	0.8 sec	2.5 sec	0.125 sec	3.5 sec
1-03	Driver's priority unlock	Off	On		
1-04	Double pulse unlock	Off	On		
1-05	Rearm Output	After Start Shutdown and First Lock	After Start Shutdown and Every Lock	After Start Only	After Shutdown Only
1-06	Reservation Lock (Manual transmissions)	Locks When Reservation Mode is Set	Does Not Lock When Reservation is Set	Reservation Sets 10 Seconds After the Last Door is Closed	
1-07	Unlock / Disarm With Trunk Release	Unlock, Factory Disarm, and Trunk Release	Factory Disarm, Trunk Release Only	Trunk Release Only	
1-08	Locking while in Passive Arming	Passive locking with Passive Arming	No Passive Locking with Passive Arming		
1-09	Ignition controlled door locks	Off	On	RPM Locks (Tach Sensing Mode Only)	
1-10	Auto Relock (If a door is not opened within this amount of time)	Off	30 sec	60 sec	5 min
1-11	Ignition / Accessory Out Upon Unlock	Off	Ignition Pulse - same timing as disarm pulse	Acc Pulse - same timing as disarm pulse	Ignition and Acc Pulse - same timing as disarm pulse
1-13	Double Pulse Disarm Input	Single Pulse	Double Pulse		
1-14	Auto Lock Mode (2 Way International Remotes)	Off	On		

OPTION GROUP 2					
THE CM4300 DOES NOT HAVE OPTIONS IN THIS MENU					
	Feature	Default Setting - I	Optional Setting - II	Optional Setting - III	Optional Setting - IV
2-01	Tach Sensing Method	Optimal Tach Method	Previous Tach Method	Low Threshold Tach Method	
2-02	Turbo Timer	Off	2 Min	1Min	4 Min
2-03	Diesel Timer	Wire	3-99sec (10sec Default)		
2-04	Trigger Start	Off	Single Pulse	Double Pulse	Triple Pulse
2-05	Cold Start with Thermistor Assembly	Off	On		
2-06	Timer Start, or, Minimum Interval Between Cold Starts	3 Hour (4 minute runtime, double for Diesel)	1.5 Hour(4 minute runtime, double for Diesel)	Reservation (Runtime set by 2-7) 2 Way LCD Remotes Only	24 Hour Repeat with Cold Starting of 2-8 (Runtime set by 2-7) 2 Way LCD Only
2-07	Remote Start Runtime	15 Min	25 Min	45 Min	3 Min
2-08	Temperature of Cold Starting	-10° C / 14° F	-20° C / -4° F	-5° C / 23° F	-15° C / 5° F
2-09	Temperature of Hot Starting	25° C / 77° F	30° C / 86° F	35° C / 95° F	40° C / 104° F
2-10	Engine Sensing	Tach	Alternator	No Connection – No Tach Sensing (Not for Manual Transmissions)	No Connection – 1.5 Second Crank (Not for Manual Transmissions V.1 or greater)
2-11	Turbo, Remote Start Runtime Extension w/ #1 for 2 seconds	No	Yes		
2-12	Crank Time	Standard	+0.2 Seconds to Crank Time	+0.6 Seconds to Crank Time (No Tach Sensing Only)	(-)0.2 Second Crank Time

OPTION GROUP 3					
	Feature	Default Setting - I	Optional Setting - II	Optional Setting - III	Optional Setting - IV
3-01	Parking lights While Remote Started	Constant Output	Flashing Output	Off	
3-02	Dome Light output	Off	Factory Rearm	45 sec	Factory Rearm + 45 Sec
3-03	Dome Light Delay	Off	5 sec	45 sec	Auto
3-04	Starter-Kill Relay	Anti-Grind + Starter Kill	Anti-Grind	Anti-Grind + Passive Starter Kill	
3-05	Anti-Jacking	Starter-kill	Ignition-Kill (no Anti-Grind)	Auto kill (Auto-door locks Off) International Remotes w/ AUTO Function Only	Auto kill (Auto-door locks On) International Remotes w/ AUTO Function Only
3-06	Factory Alarm Option (CM5200 and CM4200-DX Only)	Off	On		
3-07	Siren Duration (Upon Alarm Trigger)	30 sec	60 sec	120 Sec	Chirps for 20 seconds
3-08	Horn Output (CM5200 and CM4200-DX Only)	On Double Lock Only	On Lock and Unlock	On Lock, Unlock, and Start	On Double Lock and Start
3-09	Horn Output When Alarm Is Triggered	Pulsed Output (Horn)	Constant Output (Secondary Siren)		
3-10	Valet	Key 5 times, or Remote (I+II) while Ignition is On	Key 5 times or Remote (I+II)	Secure Valet (Default code 3,3)	
3-11	Auxiliary settings Mode	Disabled	Enabled		
3-12	Auxiliary settings With Passive Arming	No Passive Arming	Passive Arming		

OPTION GROUP 4					
	Feature	Default Setting - I	Optional Setting - II	Optional Setting - III	Optional Setting - IV
4-01	Aux 1 output	0.5sec	Latch	20 sec	Program
4-02	Aux 2 output	0.5sec	Latch	60 sec	Program
4-03	Aux 1 output Control	By Remote	Arm	Disarm	Panic
4-04	Aux 2 output Control	By Remote	Arm	Disarm	Panic
4-05	Secure Aux Output (1 and 2 Only)	On	Off		
4-06	Auxiliary Input 1 – Green CN	Prewarn	Trigger	(-)Disarm	
4-07	Auxiliary Input 2 – Green CN	Trigger	Prewarn	(-)Arm	
4-08	Extended Accessory After Ign Shutoff	Off	10 sec	30 sec	Until Door Open (1 min max)
4-09	Key Sense or Glow Plug input	Glow Plug Input	Key Sense Input		
4-10	Trigger Start or Closed Loop Alarm Trigger Input	Trigger Start input	Closed Loop System Input		
4-11	Bypass Through RS232 Port (Only Available on CM5000)	ADS	Fortin		

SPECIAL OPTION GROUP #1		
	Feature	Setting Value [seconds]
1	Diesel Timer - DISL	3 ~ 99
2	AUX1 output time	1 ~ 100
3	AUX2 output time	1 ~ 100
4	AUX3 output time	1 ~ 100
5	AUX4 output time	1 ~ 100
6	AUX5 output time	1 ~ 100
7	AUX6 output time	1 ~ 100
8	AUX7 output time	1 ~ 100

SPECIAL OPTION GROUP #2			
	Feature	Setting Value	
		0 - Default Setting	1-19 – Optional Settings
1	POC #1	(-) 2nd Parking Light (Green/White)	2nd Light - [1] 2nd Start - [2] 2nd IG1 - [3] 2nd Acc - [4] Status Out - [5] Rearm Out - [6] Disarm Out - [7] Horn Out - [8] Dome Light - [9] Aux1 Out - [10] Aux2 Out - [11] Defrost - [12] Aux4 Out - [13] Aux5 Out - [14] Aux6 Out - [15] Aux7 Out - [16] Defrost - [17] GWA - [18] Status 2 For Manual Trans. - [19] (Aux 3 through 7 Only Available on CM5000 and CM5200)
2	POC #2	(-) 2nd Start (Red/Black)	
3	POC #3	(-) 2nd Ignition (Green)	
4	POC #4	(-) 2nd Accessory (White/Black)	
5	POC #5	(-) Status/GWR (Black)	
6	POC #6	(-) Rearm Wire (Orange)	
7	POC #7	(-) Disarm Wire (Orange/White)	
8	POC #8	(-) Horn (White)	
9	POC #9	(-) Dome Light (Violet)	

Option Menu Descriptions

Only uncommon options are described in this section.

- 1-03 **Driver's Priority Unlock** - The driver's door must be isolated from the other doors. Use the Orange/Black CN4 as your 2nd Unlock output.
- 1-04 **Double Pulse Unlock** – This feature cannot be used with *Option 1-03*. This feature provides a double pulse on the blue unlock wire.
- 1-05 **Rearm Output** – Optional settings to change the event trigger on the orange rearm wire.
- 1-06 **Reservation Lock** – Manual transmission only. Setting III will provide a 10 second delay before the vehicle shuts off after closing the last door to allow for another door to open. Upon a door opening, the user will have 2 minutes to close the last door in order for reservation mode to set.
- 1-09 **Ignition Controlled Locks** – Setting 2 will lock the doors when the foot brake is pressed and doors closed. Tach sensing mode must be used for setting 3. You must also turn this feature on through the remote by tapping I+IV (2 Way remotes) or Lock+Key (1 Way remotes)
- 1-10 **Auto Relock** – This option will automatically relock/rearm after the system has been disarmed and the doors have not been opened.
- 1-11 **Ignition / Accessory Upon Unlock** – This option will pulse the ignition wire, accessory, or both upon unlock/disarm. Most new Chrysler vehicles need the ignition and accessory pulsed to disarm the factory alarm.
- 1-14 **Auto Lock Mode** – This option must be set for the Auto Mode on 2 Way international remotes to function.
- 2-01 **Tach Sensing Method** – This option will adjust the method at which tach is read by the module. At default the current setting will minimize overcrank.
- 2-02 **Turbo Mode** – This option will adjust the run time after Turbo mode has been engaged. The e-brake and door trigger input must be connected and the feature must be turned on through the remote for this feature to work.
- 2-03 **Diesel Timer** – Use this option if you can't find the glow plug wire. You can use setting 2 for a default wait to start of 10 seconds, otherwise, you can adjust the time with your OP500 Programmer.
- 2-04 **Trigger Start** – This option changes the number of times required for a negative (-) start input on Pin 12 of CN3.
- 2-05 **Cold Start** – This option turns on the cold/hot starting features. This option works in conjunction with 2-6, 2-8 and 2-9. The thermistor must be plugged into the controller/brain.
- 2-06 **Timer Start or Interval Between Cold Start** - This option dictates the time interval when the control module will either remote start or check the temperature and remote start.

Default 1: Will start every 3 hours until the vehicle is remote started or started by key and run for 4 minutes.

Option 2: Will start every 1.5 hours until the vehicle is remote started or started by key and run for 4 minutes.

Option 3: Will start at the time specified on the 2 way remote once within 24 hours and run based on Option 2-07.

Option 4: Will start once every 24 hours if the temperature falls below Option settings 2-08 or above Option settings 2-09.

For example, if you want your car to start and run 25 minutes when the temperature falls below 32°F, you need to set up the following options:

- 1) Option 2-05 (Cold Start) turned on,
 - 2) Option 2-06-IV (24 hr. repeat) turned on,
 - 3) Option 2-07-II (25 min run-time) turned on,
 - 4) Option 2-08-IV (Temp 32°F) turned on,
- *Set the reservation time at 7 am (see User's guide)

**Turn on Timer Mode of the 2 way LCD remotes (see User's Guide)

- 2-08 **Temperature of Cold Starting** – Works in conjunction with Options 2-05 and 2-06. See option table for available temperatures.
- 2-10 **Engine Sensing** – Review the “Common Procedures” section for complete explanations on the four engine sensing modes.
- 2-11 **Runtime Extension** – This option resets the engine run countdown before the vehicle shuts off for either the remote start or turbo timer. To reset the runtime you must hold the remote start button for 2.5 seconds while the unit is still running. This feature is only available on select 2 Way LCD remotes.
- 3-02 **Dome Light Output** – This option sets the timing output of the Dome Light wire on CN3.
- Default 1:** Off
Option 2: Factory Rearm – This system will pulse the dome light output during lock/arm.
Option 3: 45 second Dome Light Output – activates the dome light for 45 seconds upon unlock/disarm.
Option 4: This is a combination of 2 and 3.
- 3-03 **Dome Light Delay** – This option is used when connecting the door trigger input to the vehicles dome light circuit. It delays the door trigger input to prevent the *door open icon* displaying on 2 Way remotes upon lock/arm.
- 3-04 **Starter-Kill** – This option determines the mode of the anti-grind/starter-kill relay.
- Default 1:** Anti-grind + starter-kill
Option 2: Anti-grind only (no starter-kill)
Option 3: Anti-grind + passive starter-kill: starter-kill activates in 45 seconds after ignition is turned off.
- 3-05 **Anti-Jacking** – This option requires the starter-kill relay to be wired to the ignition vs. the starter wire.
- Default 1:** Acts like starter-kill: removes power from the ignition, which allows the car to crank but not start.
Option 2: Turns on anti-jacking: when the remote panics the system, power from the ignition will be removed at the end of the 30 second siren duration, thereby disabling the vehicle.
Option 3 & 4: Only available with Canadian remotes.
IMPORTANT: When using ignition-kill on manual transmission vehicles Option 2 will need to be utilized. Option 2 disables the anti-grind circuit while the vehicle is remote-started; if the anti-grind circuit is active and the start-kill relay is installed in the ignition, the relay will “buzz” while remote-started.
- 3-06 **Factory Style Alarm** – With this option on the control module will monitor the door triggers. If the door is opened while locked/armed then the horn will honk if connected. This is only available on the CM5200 and CM4200-DX remote starts.
- 3-08 **Horn Output** – This option will change the behavior of the horn output during lock, unlock, and remote start. This is only available on the CM5200 and CM4200-DX remote starts.

- 3-10 **Valet** – This option changes valet modes.
- Default 1:** Key on/off five times or remote valet (I + III for 0.5 seconds) with key in the on position.
Option 2: Key on/off five times or remote valet (I+III for 0.5 seconds) – key does not need to be in the on position.
Option 3: Secure valet: RPS Valet or remote valet (I+III for 0.5 seconds) – this option prevents the system from being put into valet via key on/off five times. To set up the RPS Valet feature, review the “Placement and Use of Components” section.
- 3-11 **Auxiliary settings** – This option requires the installation of the optional Auxiliary settings module. The Auxiliary settings adds five additional independent auxiliary outputs for a total of seven. With this option turned on, auxiliary 2 becomes non functional and Aux 1 becomes the data wire for the Auxiliary settings. Special Option Group 1 allows for independent timing of these outputs.
- 3-12 **Passive Arming w/Auxiliary settings** – The ability to activate/deactivate Passive Arming through the remote is lost once Option 3-11 is turned on. This option allows the use of Passive Arming when using the optional Auxiliary settings.
- 4-01 **Aux 1 Output** - This option determines the duration of the Aux 1 output. Setting IV allows the output duration to be set for a specific length of time.
- 4-02 **Aux 2 Output** - This option determines the duration of the Aux 2 output. Setting IV allows the output duration to be set for a specific length of time.
- 4-05 **Secure Aux Output** – On the default setting, button 4 on the remote must be pressed first before Aux 1 or Aux 2 can be triggered. This prevents accidental triggering of the outputs. Option setting II turns this feature off.
- 4-06 **Aux 1 Input** – This option changes the input behavior of the pre-warn wire on the Aux Input Sensor green connector.
- Default 1:** Will pre-warn with a negative (-) ground input.
Option 2: Will instant trigger with a negative (-) ground input.
Option 3: Will disarm the alarm with a negative (-) ground input. Used when adding an alarm to a factory keyless entry system.
- 4-07 **Aux 2 Input** – This option changes the input behavior of the instant trigger wire on the Aux Input Sensor green connector.
- Default 1:** Will instant trigger with a negative (-) ground input.
Option 2: Will pre-warn with a negative (-) ground input.
Option 3: Will arm the alarm with a negative (-) ground input. Used when adding an alarm to a factory keyless entry system.
- 4-08 **Extended Accessory After Ignition Shutoff** – This option keeps the Accessory wire powered up after the ignition is shut off. This can be used to keep the radio turned on even after the key is removed from the ignition (similar to GM vehicles).
- 4-09 **Glow Plug or Key Sense** – Default setting sets the wire as a glow plug input. Option setting 2 changes the wire to a key sense input. Key sense can be used to prevent reservation mode from setting and the system from passive arming while the key is still in the ignition. Key sense also turns off dome-light supervision when the key is inserted into the ignition.
- 4-10 **Trigger Start or Closed Loop System** – Default setting sets Pin 12 on CN3 as a trigger start input, which will initiate remote start with a negative (-) trigger. Option 2-04 allows the number of pulses required to initiate remote start to be changed. Setting 2 changes the wire to a closed loop input, which makes it an instant alarm trigger when separated from ground - Ideal for protecting trailers or headlights.

- 4-11 **Bypass Brand Through RS232 Port** – Default setting allows for compatibility with ADS Idatalink modules. Setting 2 changes compatibility to Fortin bypass modules. This is only available on the CM5000 and CM5200.

Special Option Groups 1 & 2

IMPORTANT: The OP500 is required to change settings in Special Option Groups 1 and 2.

Special Option Group 1

- 1 **Diesel Timer** – Option 2-03 must first be set to setting 2. This special option allows a specific wait to start time (in seconds) to be programmed. This prevents the need for a timer relay and eliminates a connection to the “wait to start” wire.
- 2 **Aux 1 Output Timing** – Option 4-01 must first be set to setting 4. This special option allows a specific output duration for Aux 1 to be programmed.
- 3 **Aux 2 Output Timing** – Option 4-02 must first be set to setting 4. This special option allows a specific output duration for Aux 2 to be programmed.
- 4-8 **Aux 3 – 7 Output Timing** – Option 3-11 must first be set to setting 2 and the optional Auxiliary settings module must be used. These special options allow specific output durations to be set for Aux 3 – 7. Only available with 2 Way LCD remotes.

Special Option Group 2

This special option group allows you to determine the output type of the POC wires on CN3. For example, if you want to set POC #5 (default setting status out) to Aux 1, you will need change special option 5 to number 10. This must be done with the OP500.

Option Programming

Option Programming Using the OP500 (programmer)

The OP500 can be used to program any available option. It is **required** to program options in Special Option Groups 1 and 2.

STEP 1: Using the blue connector on the top of the OP500, connect it to the control module via the antenna wire. (Use the included extension cable if necessary.) Once connected, the OP500 will power up as long as the main ignition harness to the controller has been connected properly.

STEP 2: To change the option number you wish to program, use the left and right arrow keys on the OP500. It will scroll through the options available in menu 1 and then move to menu 2, then 3 and 4. Use the up and down arrow buttons on the OP500 to adjust the option settings; “1” is the default setting, and “2”, “3”, and “4” are the optional settings

At the end of menu 4, if diesel mode or auxiliary settings functions were enabled – or if any of the auxiliary outputs were set to “Program”, the duration of these settings can now be adjusted.

Following the auxiliary and diesel settings (if selected), the POC options will be displayed on the OP500. The POCs can be set between 0 (default) and 19. All are only available on the CM5000.

STEP 3: When finished with the adjustment of the various option settings, press and hold the “W” (write) button until the OP500 chirps, which is approximately 2.5 seconds. This will write the settings to the control module. Wait until the module displays “Success” before disconnecting it from the antenna cable.

To reset the options, hold the “R” (reset) button and the “W” (write) button for 2.5 seconds. Release then write the reset, hold the “W” button until the OP500 chirps, which is approximately 2.5 seconds.

Option Programming Using a Remote

Using a remote is a timed process so read this section in its entirety before beginning.

IMPORTANT: Special Option Groups cannot be programmed with a remote – the OP500 must be used.

STEP 1: Select the option menu that contains the desired programming option.

To program options use the following button combinations:

How To Program Options With 2 Way Remotes						
	With 2 Way Remotes	Scroll Through Menu	Select Option 1	Select Option 2	Select Option 3	Select Option 4
Option Menu 1	(1 + 2) for 2.5 seconds then (1 + 2) for 2.5 seconds	Tap Button 4	Tap Button 1	Tap Button 2	Tap Button 3	Tap Button 4
Option Menu 2	(1 + 2) for 2.5 seconds then (1 + 4) for 2.5 seconds	Tap Button 4	Tap Button 1	Tap Button 2	Tap Button 3	Tap Button 4
Option Menu 3	(1 + 4) for 2.5 seconds then (1 + 2) for 2.5 seconds	Tap Button 4	Tap Button 1	Tap Button 2	Tap Button 3	Tap Button 4
Option Menu 4	(1 + 4) for 2.5 seconds then (1 + 4) for 2.5 seconds	Tap Button 4	Tap Button 1	Tap Button 2	Tap Button 3	Tap Button 4

How To Program Options With 1 Way Remotes						
	With 1 Way Remotes	Scroll Through Menu	Select Option 1	Select Option 2	Select Option 3	Select Option 4
Option Menu 1	Lock + Unlock for 2.5 seconds then Lock + Unlock for 2.5 seconds	Hold Trunk + Key/Start for 2.5 seconds	Tap Lock Button	Tap Unlock Button	Tap Key/Start Button	Hold Trunk + Key/Start for 2.5 seconds
Option Menu 2	Lock + Unlock for 2.5 seconds then Lock + Key/Start for 2.5 seconds	Hold Trunk + Key/Start for 2.5 seconds	Tap Lock Button	Tap Unlock Button	Tap Key/Start Button	Hold Trunk + Key/Start for 2.5 seconds
Option Menu 3	Lock + Key/Start for 2.5 seconds then Lock + Unlock for 2.5 seconds	Hold Trunk + Key/Start for 2.5 seconds	Tap Lock Button	Tap Unlock Button	Tap Key/Start Button	Hold Trunk + Key/Start for 2.5 seconds
Option Menu 4	Lock + Key/Start for 2.5 seconds then Lock + Key/Start for 2.5 seconds	Hold Trunk + Key/Start for 2.5 seconds	Tap Lock Button	Tap Unlock Button	Tap Key/Start Button	Hold Trunk + Key/Start for 2.5 seconds

STEP 2: Scroll through menu allowing for 1 parking light flash and/or siren chirp per step.

STEP 3: Once finished scrolling through the menu wait for the parking lights and/or siren chirp to confirm the option number. i.e. option 2-04 will flash 4 times. Then use one of the table selections to select the option corresponding to your desired setting.

Resetting to Factory Defaults: To reset the options in a particular menu group, enter the menu shown in the above tables. To reset options with a 2 Way remote tap button 3 three times. To reset options with a 1 Way remote tap the Key/Start button 3 times. Wait for the siren to chip and parking lights to flash between each tap. After the third tap, the option menu will reset and the siren will chirp three times. This must be done for each option group that needs to be reset.

Troubleshooting

Remote Start Error Codes

If the remote start fails to start the vehicle, the parking lights will flash three times immediately. Following those three flashes the parking lights will flash again corresponding to the error table below:

Number of Parking Light Flashes	Remote Start Error
1	Motor running or must program tach before 1 st remote start
2	Key in ignition on position
3	Door open (manual transmission only)
4	Trunk open
5	Foot brake on
6	Hood open
7	Reservation off (manual transmission only)
8	Tach or no tach sensing failure

*Pro 2 Way remotes will display the error number "Strt Er##" on the LCD.

Alarm LED Diagnostics

Alarm and Alarm / Starter Control Modules Only

When the alarm is triggered the LED on the RPS (if installed), Secure Valet (if installed) and the LED (if installed) will flash a certain amount of times as shown in the table below. This is intended for users with 1 Way remotes.

Priority	Trigger	LED Flash Diagnostic
1	Door/Hood/Trunk/Ign Triggered	2 flashes, rest, then repeat
2	2 nd Shock Triggered	3 flashes, rest, then repeat
3	2 nd Auxiliary Input Triggered	4 flashes, rest, then repeat
4	Panic with remote	5 flashes, rest, then repeat

Frequently Asked Questions

I have everything hooked up and the system will not respond.

A: The remotes need to be programmed. Review the "Common Procedure" section of this manual.

I have these control modules that say MM720 and MM721. What are they?

A: These control modules are the new CM5 series. MM720 = CM5000 and MM721 = CM5200.

I am trying to program the control module with the OP500 Option Programmer and it flashes “ER 01” when I plug it in to the antenna cable. What should I do?

A: Make sure that the system is not locked/armed. The last thing to check is the antenna cable or antenna extension cable – make sure this is not damaged. If you need to, try another cable. When the OP500 is working properly, it will read “success good.” You no longer need to program the remotes before the OP500 will sync. This is new with the CM4 and CM5 series V.37 and V.4 respectively updates.

What is the green loop wire inside the brain module?

A: This wire determines the transmission mode. With the loop intact, the system is set for manual transmissions. With the loop cut, the system is set for automatic transmission.

Where do the blue and purple wires off the extra relay go on the CM4000/CM4200-DX/CM5000/CM5200?

A: This is a pre-wired positive output, negative trigger relay. Use the secondary ignition, starter, and accessory outputs from CN3 to give a negative trigger to the purple wire. This will determine the 12V positive (+) output of the blue wire, which you can then connect to your secondary ignition, starter, or accessory wire.

I need a ground when armed wire, does the control module have one?

A: You can use the starter output on CN1 that goes to the starter kill relay. You must cut this wire and place a diode in line so that when the ignition on the other side of the relay goes to ground, it won't back feed to your accessory. Install the stripe side of the diode facing the control module.

Are the CM4 and CM5 series non tach sensing?

A: Yes. The CM4000, CM4200-DX, CM5000, and CM5200 all have no tach sensing. Review the “Common Procedures” section of this manual.

On the brain, how do I set the auxiliaries?

A: You must have an Option Programmer (OP500) to set the auxiliaries on the CM4000, CM4200-DX, CM4300, CM5000, and CM5200. First you must choose two POC wires on CN3 that you are not using. With the OP500 go into the Special Option Group 2 and set those POC's to Aux 1 and Aux 2. Review the “Special Option Group” programming section of this manual.

All my connections are made and remotes programmed, how do I program the tach?

A: Review the “Common Procedures” section of this manual.

The vehicle remote starts when disarmed, but not when armed.

A: The starter kill relay was installed backwards. Check to make sure the yellow/black wire is going to the ignition side of the wire, and that the yellow wire is going to the engine side.

The vehicle starts and shuts down 3 times in a row.

A: This usually means that the engine sensing mode is not working correctly. If you are using a coil, change to an injector or try alternator mode.

The vehicle will lock and unlock, but will not remote start or flash the parking lights.

A: The system is in valet mode. Tap buttons (I) + (III) for 0.5 seconds while the key is in the on position.

Whenever I try to arm the vehicle, it chirps the siren 3 times and will not arm.

A: Check the hood and trunk trigger inputs.

When I turn the ignition on the parking lights flash 3 times and/or siren chirps 3 times. What is the problem?

A: When you program only 1 Way remotes to a 2 Way antenna and no 2 Way remotes the control module reminds you of this situation each time you turn the ignition on. It does not affect the operation of the system but will continue to do so until you program both 2 and 1 Way remotes to the 2 Way antenna.

Do the door locks flip flop in polarity?

A: No. You can use the CompuPack (relay pack) for high current positive (+) locks, or the DM600 harness used for low current 600mA positive (+) locks.

What are Firmware Version Diagnostics?

A: When you turn the Ignition on and hold buttons 1 and 4 or Lock and Key/Start for 2.5 seconds then the parking lights will flash 1 time on the CM5 series showing V.1. The lights will flash 2 times on the CM4 series showing V.33. Current versions of CM4 Series V.37 and CM5 Series V.4 will flash 5 times when attempting Version Diagnostics.

What is this cartridge slot on the rear of the CM5000 and CM5200?

A: This is the slot for the Blade cartridge system by ADS. This slot is for the Idatalink Blade remote start bypass modules. For more information on the compatibility and install information please visit www.idatalink.com/fitguide. Using this system eliminates many connections between your standard control module and bypass module. **IMPORTANT:** If you are not using the Blade then you will not have or use the 20 pin connector next to the back up battery port.

Technical Support Contacts

Firstech technical support is reserved for authorized dealers only.

Monday - Friday

888-820-3690
(7:00 am – 5:00 pm Pacific Coast Time)

Email

support@compustar.com

Web

<http://www.compustar.com> click on “dealer support”

 Wire Diagrams

Click on the “Installogy Access Client” link found on your desktop. If you are a qualified dealer and unable to access this site, call your sales representative or the number above.